

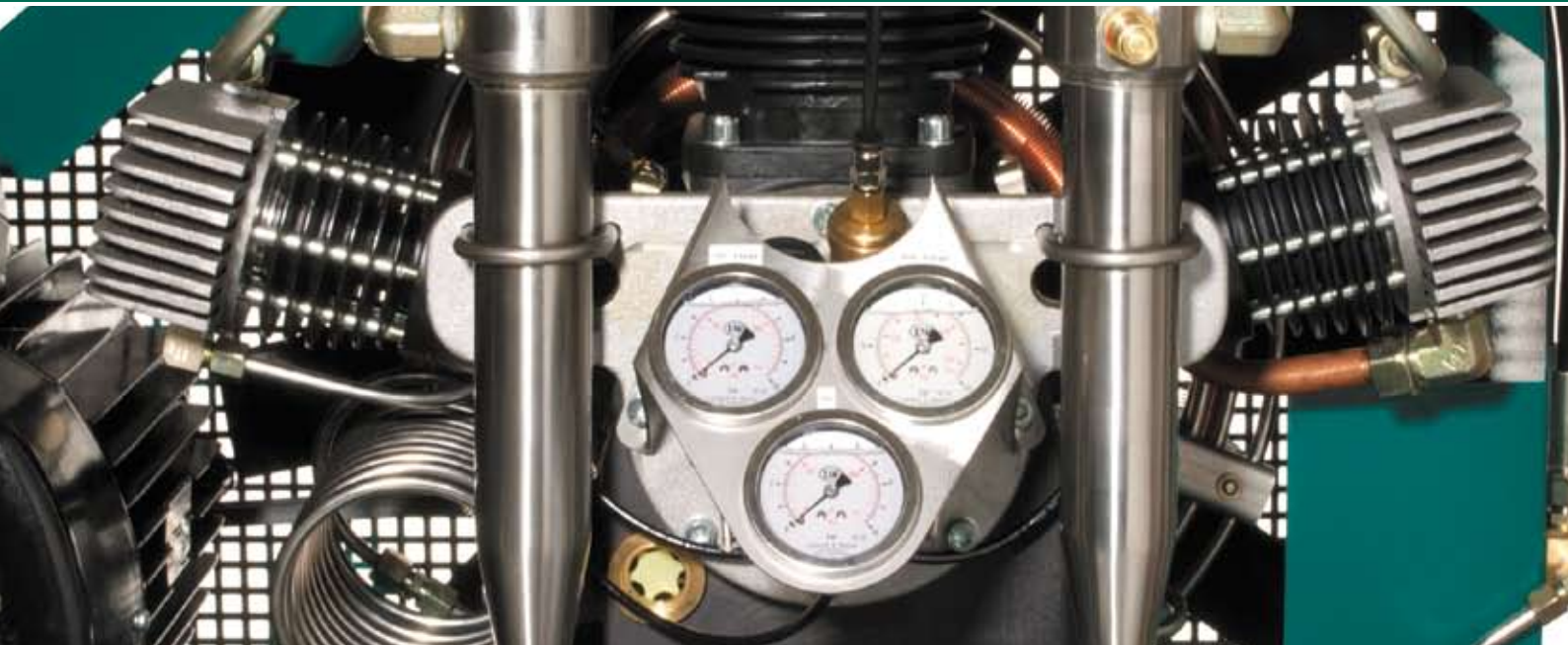

## MAIN CATALOGUE



Compressors | Purification | Storage | Filling Panels | Nitrox/Trimix



High Pressure Solutions from L&W!

## Lenhardt & Wagner

Users all over the world have placed their trust and are successfully using L&W high pressure compressors and the associated products to fulfil their demands in a wide range of applications.

Excellent value for the investment, low costs of ownership and sturdy, reliable units matched to your objective and backed up by a network of service and support centres ensure trouble free economical and effective solutions.

The internal quality management system at L&W's main manufacturing facility in Germany is ISO 9001 certified with regular audits. The high pressure equipment is manufactured in accordance with the latest EU guidelines for machinery and pressure equipment (e.g. PED 97/23).

Additional certification by notified bodies such as: TÜV, German Lloyd, DNV, GOST, UDT, ABS, etc. are available upon request.



# Table of Contents

## Compressors

LW 100 E / LW 100 E1 / LW 100 B	6 - 7
LW 160 E / LW 160 E1 / LW 190 B	8 - 9
LW 225 E / LW 245 B	10 - 11
LW 170 E / LW 200 E / LW 170 D / LW 170 D AL	12 - 13
LW 280 E Compact / LW 280 E1 Compact	14 - 15
LW 230 E / LW 280 E	16 - 17
LW 230 ES / LW 280 ES	18 - 19
LW 300 B Nautic	20 - 21
LW 300 E / LW 450 E	22 - 23
LW 300 ES / LW 450 ES	24 - 25
LW 450 D Basic	26 - 27
LW 450 D	28 - 29
LW 570 E	30 - 31
LW 570 ES	32 - 33
LW 570 D	34 - 35
LW 720 E	36 - 37
LW 1300 E	38 - 39
Electronic Compressor Control	40

## Purification

Puracon Moisture Controller	41
LW Air Cooler +3°C / Filtration	42 - 43

## Storage

Storage Cylinders / Storage Management	44 - 46
--	---------

## Air Station

47

## Filling Panels

48 - 49

## Nitrox/Trimix

Alpha 1 Oxygen Analyser	50
Nitrox Membrane Systems	51 - 53
Gas Blending Panels	54

## Accessories

Filling Connections	55
Filter Cartridges / Oil and Inlet Filters	56 - 57
Filling Valves / Safety Valves / Pressure Switches and Sensors	58 - 59
Air Inlet Silencer / Condensation Collecting Tank	60
Pressure Reducing Stations / Pressure Reducers	61
Adapters	62

# High pressure solutions by L&W

## Compressors

High pressure piston compressors from 100 – 420 bar with electric, gasoline or diesel drive.

Page 6 - 40



## Purification

Purification with refrigeration dryers or with filter towers.

Page 41 - 43



## Storage

High pressure storage.

Page 44



## Storage management

Solutions for controlling storage for optimum efficiency.

Page 45 - 46



## Filling Panels

Ergonomically designed filling panels.

Page 48 - 49



## Nitrox/Trimix

Solutions for mixed gas production and filling for diving applications.

Page 50 - 54



## Air Station

Filling stations for 24 hour / 7 days a week filling services.

Page 47

# Compressor Overview

Type	Application			Prime mover	Mobility	Capacity [l/min] / [Nm <sup>3</sup> /h] / [cfm]	Drive power [kW] / [HP]	Page
	Breathing Air	HP Air	Inertgas					
LW 100 E	●	●	●	3 Phase Power	Mobile	100 / 6.0 / 3.5	2.2 / 3.0	6
LW 100 E1	●	●	●	Single Phase power	Mobile	100 / 6.0 / 3.5	2.2 / 3.0	6
LW 100 B	●	●	●	Gasoline	Mobile	100 / 6.0 / 3.5	4.5 / 6.0	7
LW 160 E	●	●	●	3 Phase Power	Mobile	160 / 9.6 / 5.6	4.0 / 5.5	8
LW 160 E1	●	●	●	Single Phase power	Mobile	160 / 9.6 / 5.6	4.0 / 5.5	8
LW 190 B	●	●	●	Gasoline	Mobile	190 / 11.4 / 6.7	6.0 / 9.0	9
LW 225 E	●	●	●	3 Phase Power	Mobile	225 / 13.5 / 7.9	5.0 / 7.5	10
LW 245 B	●	●	●	Gasoline	Mobile	245 / 14.7 / 8.7	6.0 / 9.0	11
LW 170 E	●	●	●	3 Phase Power	Mobile	170 / 10.2 / 6.0	4.0 / 5.5	12
LW 200 E	●	●	●	3 Phase Power	Mobile	200 / 12.0 / 7.0	5.5 / 7.5	12
LW 170 D	●	●	●	Diesel	Mobile	170 / 10.2 / 6.0	4.8 / 6.5	13
LW 170 D AL	●	●	●	Diesel	Mobile	170 / 10.2 / 6.0	4.8 / 6.5	13
LW 280 E Compact	●	●	●	3 Phase Power	Stationary	280 / 16.8 / 9.9	7.5 / 10.0	15
LW 280 E1 Compact	●	●	●	Single Phase power	Stationary	280 / 16.8 / 9.9	7.5 / 10.0	15
LW 230 E	●	●	●	3 Phase Power	Stationary	230 / 13.8 / 8.1	5.5 / 7.5	17
LW 280 E	●	●	●	3 Phase Power	Stationary	280 / 16.8 / 9.9	7.5 / 10.0	17
LW 230 ES *	●	●	●	3 Phase Power	Stationary	230 / 13.8 / 8.1	5.5 / 7.5	19
LW 280 ES *	●	●	●	3 Phase Power	Stationary	280 / 16.8 / 9.9	7.5 / 10.0	19
LW 300 B Nautic	●	●	●	Gasoline	Stationary	300 / 18.0 / 10.6	8.2 / 11.0	21
LW 300 E	●	●	●	3 Phase Power	Stationary	300 / 18.0 / 10.6	7.5 / 10.0	23
LW 450 E	●	●	●	3 Phase Power	Stationary	450 / 27.0 / 15.9	11.0 / 15.0	23
LW 300 ES *	●	●	●	3 Phase Power	Stationary	300 / 18.0 / 10.6	7.5 / 10.0	25
LW 450 ES *	●	●	●	3 Phase Power	Stationary	450 / 27.0 / 15.9	11.0 / 15.0	25
LW 450 D Basic	●	●	●	Diesel	Stationary	450 / 27.0 / 15.9	10.5 / 14.3	27
LW 450 D	●	●	●	Diesel	Stationary	450 / 27.0 / 15.9	10.5 / 14.3	29
LW 570 E	●	●	●	3 Phase Power	Stationary	570 / 34.0 / 20.1	15.0 / 20.0	31
LW 570 ES *	●	●	●	3 Phase Power	Stationary	570 / 34.0 / 20.1	15.0 / 20.0	33
LW 570 D	●	●	●	Diesel	Stationary	570 / 34.0 / 20.1	12.9 / 17.5	35
LW 720 E	●	●	●	3 Phase Power	Stationary	720 / 43.2 / 25.4	18.5 / 25.0	37
LW 1300 E	●	●	●	3 Phase Power	Stationary	1300 / 78.0 / 45.9	37.0 / 50.0	39

\* Sound insulated

# LW 100 E / E1

The compressors are ready to plug in and come with a cable, plug and start/stop switch.  
Ideal for small applications or occasional filling operations.

## Specifications

- >> Fully wired, ready to start with cable and plug, start/stop switch
- >> 1 Filling hose with filling valve and pressure gauge
- >> 200/232 bar version with DIN/Yoke connection, 300 bar version with DIN connection
- >> Stainless steel frame with carrying handles
- >> Fan belt guard and block cowling for improved cooling air flow
- >> 2 oil/water separators, safety valve for each stage
- >> Inter-stage and final stage air coolers
- >> Pressure maintaining and non return valve for extended filter duration
- >> Breathing air purification in accordance with EN 12021



LW 100 E1

## Options

- >> Additional filling hose
- >> 200/300 bar switch over device
- >> Automatic stop and hours counter
- >> Special voltages/frequencies:  
440V 60 Hz (E) / 230V 50Hz (E) / 230V 60Hz (E / E1)
- >> Conversion set petrol/electric drive



LW 100 E

## Technical Data

	LW 100 E	LW 100 E1
Type:	Air cooled, reciprocating piston compressor	Air cooled, reciprocating piston compressor
Capacity [litre/min] / [Nm <sup>3</sup> /h] / [cfm]:	100 / 6 / 3.5	100 / 6 / 3.5
Max. Pressure [bar]:	330 (set at the final stage safety valve)	330 (set at the final stage safety valve)
RPM:	2300	2300
No of cylinders / No of stages:	3 / 3	3 / 3
Prime mover type:	3 Phase E-motor 400V / 50Hz <sup>1)</sup>	Single phase E-Motor 230V 50Hz <sup>1)</sup>
Drive power [kW] / [HP]:	2.2 / 3.0	2.2 / 3.0
Cooling air requirement [Nm <sup>3</sup> /h]:	660	660
Lubrication type:	Splash	Splash
Oil capacity [litre]:	0.5	0.5
Air outlet temperature [°C]:	6°C above ambient	6°C above ambient
Filter capacity [m <sup>3</sup> at +20°C <sup>2)</sup> ]:	108	108
Dimensions L x W x H [cm]:	65 x 39 x 40	65 x 39 x 40
Weight [kg]:	43	46
Noise level [dB]:	82 dB(A) measured at 1m	82 dB(A) measured at 1m

<sup>1)</sup> Special voltages/frequencies available on request <sup>2)</sup> In accordance with EN 12021



For light and mobile filling applications, independent of power supply. Ideal for expeditions, dive holidays in remote locations or in mobile repair/construction applications. The self contained unit is equipped with a reliable Vanguard 4 stroke motor and extremely easy to operate.

## Specifications

- >> Ready to start unit with 4 stroke 4.4 kW Vanguard 118400 motor with pull start
- >> Drive motor with auto cut off for low oil level
- >> Collapsible snorkel for air inlet
- >> 1 Filling hose with filling valve and pressure gauge
- >> 200/232 bar version with DIN/Yoke connection, 300 bar version with DIN connection
- >> Stainless steel frame with carrying handles
- >> Fan belt guard and block cowling for improved cooling air flow
- >> 2 oil/water separators, safety valve for each stage
- >> Inter-stage and final stage air coolers
- >> Breathing air purification in accordance with EN 12021
- >> Pressure maintaining and non return valve for extended filter duration

## Options

- >> Additional filling hose
- >> Automatic stop at final pressure
- >> 200/300 bar switch over device
- >> Conversion set petrol/electric drive



LW 100 B

## Technical Data

	LW 100 B
Type:	Air cooled, reciprocating piston compressor
Capacity [litre/min] / [Nm <sup>3</sup> /h] / [cfm]:	100 / 6 / 3.5
Max. Pressure [bar]:	330 (set at the final stage safety valve)
RPM:	2300
No of cylinders / No of stages:	3 / 3
Prime mover type:	4 stroke gasoline engine, hand start
Drive power [kW] / [HP]:	4.5 / 6.0
Cooling air requirement [Nm <sup>3</sup> /h]:	660
Lubrication type:	Splash
Oil capacity [litre]:	0.5
Air outlet temperature [°C]:	6°C above ambient
Filter capacity [m <sup>3</sup> at +20°C] <sup>2)</sup> :	108
Dimensions L x W x H [cm]:	70 x 38 x 45
Weight [kg]:	43
Noise level [dB]:	93 dB[A] measured at 1 m

<sup>2)</sup> In accordance with EN 12021

# LW 160 E / E1

Portable compressors without compromising power and capacity. The L&W 160 compressors are compact and extremely easy to operate, the units have established themselves over the years as reliable compressors. The compressors are ready to run and come with a cable, plug and phase selector switch for easy direction of rotation control. Ideal for small applications or sporadic filling operations.

## Specifications

- >> Fully wired, ready to start with cable, plug and phase selector (E)
- >> 1 Filling hose with filling valve and pressure gauge
- >> Steel frame with carrying handles
- >> GRP fan belt guard
- >> 2 oil/water separators, safety valve for each stage
- >> Stainless steel cooling pipes and inter-coolers
- >> Breathing air purification in accordance with EN 12021
- >> Pressure maintaining valve for extended filter duration

## Options

- >> Additional filling hose
- >> Automatic stop at final pressure
- >> Automatic condensation drain
- >> 200/300 bar switch over device
- >> Hours counter
- >> Special voltages/frequencies:  
440V 60 Hz (E) / 230V 50Hz (E) / 230V 60Hz (E / E1)
- >> Conversion set petrol/electric drive



LW 160 E

## Technical Data

	LW 160 E	LW 160 E1
Type:	Air cooled, reciprocating piston compressor	Air cooled, reciprocating piston compressor
Capacity [litre/min] / [Nm <sup>3</sup> /h] / [cfm]:	160 / 9.6 / 5.6	160 / 9.6 / 5.6
Max. Pressure [bar]:	330 (set at the final stage safety valve)	330 (set at the final stage safety valve)
RPM:	1450	1450
No of cylinders / No of stages:	3 / 3	3 / 3
Prime mover type:	3 Phase E-motor 400V / 50Hz <sup>1)</sup>	Single phase E-Motor 230V 50Hz <sup>1)</sup>
Drive power [kW] / [HP]:	4.0 / 5.5	3.7 / 5.0
Cooling air requirement [Nm <sup>3</sup> /h]:	1200	1200
Lubrication type:	Plunger/Splash	Plunger/Splash
Oil capacity [litre]:	0.8	0.8
Air outlet temperature [°C]:	8 - 10°C above ambient	8 - 10°C above ambient
Filter capacity [m <sup>3</sup> at +20°C] <sup>2)</sup> :	180	180
Dimensions L x W x H [cm]:	78 x 42 x 56	78 x 42 x 56
Weight [kg]:	90	94
Noise level [dB]:	84 dB[A] measured at 1 m	84 dB[A] measured at 1 m

<sup>1)</sup> Special voltages/frequencies available on request    <sup>2)</sup> In accordance with EN 12021



Portable compressor with a reliable Honda 4 stroke motor for optimum mobility and reliability independent of power supplies. The easy to operate units have established themselves as ideal compressors for remote expeditions and safaris. Despite the compact form and mobility, the filling times are kept to a minimum with high delivery rates.

## Specifications

- >> Ready to start unit with 4 stroke 6.6 kW Honda motor with pull start
- >> Drive motor with auto cut off for low oil level
- >> 1 Filling hose with filling valve and pressure gauge
- >> GRP fan belt guard
- >> Steel frame with carrying handles
- >> 2 oil/water separators, safety valve for each stage
- >> Stainless steel cooling pipes and inter-coolers
- >> Breathing air purification in accordance with EN 12021
- >> Pressure maintaining valve for extended filter duration
- >> 2.5 m air inlet hose

## Options

- >> Additional filling hose
- >> Automatic stop at final pressure
- >> 200/300 bar switch over device
- >> Conversion set petrol/electric drive



LW 190 B with optional 200/300 bar module

## Technical Data

	LW 190 B
Type:	Air cooled, reciprocating piston compressor
Capacity [litre/min] / [Nm <sup>3</sup> /h] / [cfm]:	190 / 11.4 / 6.7
Max. Pressure [bar]:	330 (set at the final stage safety valve)
RPM:	1900
No of cylinders / No of stages:	3 / 3
Prime mover type:	4 stroke gasoline engine, hand start
Drive power [kW] / [HP]:	6.6 / 9.0
Cooling air requirement [Nm <sup>3</sup> /h]:	1800
Lubrication type:	Plunger/ Splash
Oil capacity [litre]:	0.8
Air outlet temperature [°C]:	8 - 10°C above ambient
Filter capacity [m <sup>3</sup> at +20°C] <sup>2)</sup> :	180
Dimensions L x W x H [cm]:	92 x 43 x 57
Weight [kg]:	99
Noise level [dB]:	93 dB[A] measured at 1 m

<sup>2)</sup> In accordance with EN 12021

# LW 225 E

A portable compressor without compromising power and capacity. The 225 E is small and light enough for mobility, yet powerful enough for stationary applications. The compressors are ready to run and come with a cable, plug and phase selector switch for easy direction of rotation control.

## Specifications

- >> Fully wired, ready to start with cable, plug and phase selector
- >> 1 Filling hose with filling valve and pressure gauge
- >> Steel frame with carrying handles
- >> GRP fan belt guard
- >> 2 oil/water separators, safety valve for each stage
- >> Stainless steel cooling pipes and inter-coolers
- >> Breathing air purification in accordance with EN 12021
- >> Pressure maintaining valve for extended filter duration

## Options

- >> Additional filling hose
- >> 200/300 bar switch over device
- >> Automatic stop at final pressure
- >> Automatic condensation drain
- >> Hours counter
- >> Special voltages/frequencies:  
440V 60 Hz / 230V 50Hz / 230V 60Hz
- >> Conversion set petrol/electric drive



LW 225 E

## Technical Data

	LW 225 E
Type:	Air cooled, reciprocating piston compressor
Capacity [litre/min] / [Nm <sup>3</sup> /h] / [cfm]:	225 / 13.5 / 7.9
Max. Pressure [bar]:	330 (set at the final stage safety valve)
RPM:	1850
No of cylinders / No of stages:	3 / 3
Prime mover type:	3 Phase E-motor 400V / 50Hz
Drive power [kW] / [HP]:	5.5 / 7.5
Cooling air requirement [Nm <sup>3</sup> /h]:	1650
Lubrication type:	Plunger/Splash
Oil capacity [litre]:	0.8
Air outlet temperature [°C]:	8 - 10 C° above ambient
Filter capacity [m <sup>3</sup> at +20°C] <sup>2)</sup> :	200
Dimensions L x W x H [cm]:	78 x 45 x 56
Weight [kg]:	92
Noise level [dB]:	87 dB[A] measured at 1 m

<sup>2)</sup> In accordance with EN 12021

Portable compressor with a reliable Honda 4 stroke motor for optimum mobility and reliability independent of power supplies. The easy to operate units have established themselves as ideal compressors for remote expeditions and safaris. Despite the compact form and low weight, the filling times are kept to a minimum with a powerful delivery rate.

## Specifications

- >> Ready to start unit with 4 stroke 6.6 kW Honda motor with pull start
- >> Drive motor with auto cut off for low oil level
- >> 1 Filling hose with filling valve and pressure gauge
- >> GRP fan belt guard
- >> Steel frame with carrying handles
- >> 2 oil/water separators, safety valve for each stage
- >> Stainless steel cooling pipes and inter-coolers
- >> Breathing air purification in accordance with EN 12021
- >> Pressure maintaining valve for extended filter duration
- >> 2.5 m air inlet hose

## Options

- >> Additional filling hose
- >> Automatic stop at final pressure
- >> 200/300 bar switch over device
- >> Conversion set petrol/electric drive



LW 245 B

## Technical Data

	LW 245 B
Type:	Air cooled, reciprocating piston compressor
Capacity [litre/min] / [Nm <sup>3</sup> /h] / [cfm]:	245 / 14.7 / 8.7
Max. Pressure [bar]:	330 (set at the final stage safety valve)
RPM:	2000
No of cylinders / No of stages:	3 / 3
Prime mover type:	4 stroke gasoline engine, hand start
Drive power [kW] / [HP]:	6.6 / 9.0
Cooling air requirement [Nm <sup>3</sup> /h]:	1800
Lubrication type:	Plunger/ Splash
Oil capacity [litre]:	0.8
Air outlet temperature [°C]:	8 - 10°C above ambient
Filter capacity [m <sup>3</sup> at +20°C] <sup>2)</sup> :	200
Dimensions L x W x H [cm]:	92 x 45 x 57
Weight [kg]:	94
Noise level [dB]:	93 dB[A] measured at 1 m

<sup>2)</sup> In accordance with EN 12021

# LW 170 E / LW 200 E

The electrically driven Nautic compressors are ideal for medium sized stationary applications where mobility is also desirable. The compressors are 3 stage blocks mounted in a sturdy powder coated crash frame with foldable carrying handles and sling eyes for crane/helicopter transport. The frames provide excellent protection and are designed to allow easy transportation.

## Specifications

- >> Fully wired, ready to start with cable, plug and phase selector
- >> Operating panel with Start/Stop switch and running lamp
- >> Filling pressure gauge and hours counter
- >> Crash frame with 4 carrying handles and sling eyes, powder coated in RAL 6026
- >> GRP fan belt guard
- >> 2 oil/water separators, safety valve for each stage
- >> Stainless steel cooling pipes and inter-coolers
- >> Breathing air purification in accordance with EN 12021
- >> Pressure maintaining valve for extended filter duration
- >> 2 self-venting, lever operated filling valves with hoses and connections

## Options

- >> 2 extra filling hoses
- >> Automatic stop at final pressure
- >> Automatic condensation drain
- >> 200/300 bar parallel filling pressures
- >> Motor protection switches
- >> Special voltages/frequencies:  
440V 60 Hz / 230V 50Hz / 230V 60Hz



LW 200 E Nautic

## Technical Data

	LW 170 E	LW 200 E
Type:	Air cooled, reciprocating piston compressor	Air cooled, reciprocating piston compressor
Capacity [litre/min] / [Nm <sup>3</sup> /h] / [cfm]:	170 / 10.2 / 6.0	200 / 12.0 / 7.0
Max. Pressure [bar]:	330 (set at the final stage safety valve)	330 (set at the final stage safety valve)
RPM:	1530	1650
No of cylinders / No of stages:	3 / 3	3 / 3
Prime mover type:	3 Phase E-motor 400V / 50Hz	3 Phase E-motor 400V / 50Hz
Drive power [kW] / [HP]:	4.0 / 5.5	5.5 / 7.5
Cooling air requirement [Nm <sup>3</sup> /h]:	1200	1650
Lubrication type:	Plunger/Splash	Plunger/Splash
Oil capacity [litre]:	0.8	0.8
Air outlet temperature [°C]:	8 - 10°C above ambient	8 - 10°C above ambient
Filter capacity [m <sup>3</sup> at +20°C] <sup>2)</sup> :	180	200
Dimensions L x W x H [cm]:	103 x 50 x 73	103 x 50 x 73
Weight [kg]:	135	137
Noise level [dB]:	85 dB[A] measured at 1 m	86 dB[A] measured at 1 m

<sup>2)</sup> In accordance with EN 12021

# LW 170 D / LW 170 D AL

Self-contained diesel driven compressors ideal for small or medium sized applications independent of power. The diesel provides the ideal drive for these workhorses that can be located or transported where HP air is needed.

## Specifications

- >> Ready to use unit with Yanmar L70 4.8 kW motor
- >> 12V Electric start and pull start with decompression
- >> Instrument panel with key start and generator warning lamp
- >> Integrated pressure gauge and hours counter
- >> Crash frame with 4 carrying handles and sling eyes, powder coated in RAL 6026
- >> GRP fan belt guard
- >> Stainless steel diesel tank, capacity approx. 7 hours running time
- >> 2 oil/water separators, safety valve for each stage
- >> Stainless steel cooling pipes and inter-coolers
- >> Breathing air purification in accordance with EN 12021
- >> Pressure maintaining and non return valve for extended filter duration
- >> 2.5 m air inlet hose
- >> 2 self-venting, lever operated filling valves with hoses and connections

## LW 170 D AL

Sea water resistant aluminium crash frame (reduces weight by 25 kg) powder coated in RAL 9006

## Options

- >> 2 extra filling hoses
- >> Automatic stop at final pressure
- >> Automatic condensation drain
- >> 200/300 bar parallel filling pressures



LW 170 D AL Nautic

## Technical Data

	LW 170 D / LW 170 D AL
Type:	Air cooled, reciprocating piston compressor
Capacity [litre/min] / [Nm <sup>3</sup> /h] / [cfm]:	170 / 10.2 / 6.0
Max. Pressure [bar]:	330 (set at the final stage safety valve)
RPM:	1530
No of cylinders / No of stages:	3 / 3
Prime mover type:	Air cooled diesel, electric start
Drive power [kW] / [HP]:	4.8 / 6.5
Cooling air requirement [Nm <sup>3</sup> /h]:	1500
Lubrication type:	Plunger/Splash
Oil capacity [litre]:	0.8
Air outlet temperature [°C]:	8 - 10°C above ambient
Filter capacity [m <sup>3</sup> at +20°C] <sup>1)</sup> :	180
Dimensions L x W x H [cm]:	103 x 50 x 73
Weight [kg]:	150 / 125 (170 D AL)
Noise level [dB]:	92 dB[A] measured at 1 m

<sup>1)</sup> In accordance with EN 12021



# LW 280 E / E1 Compact

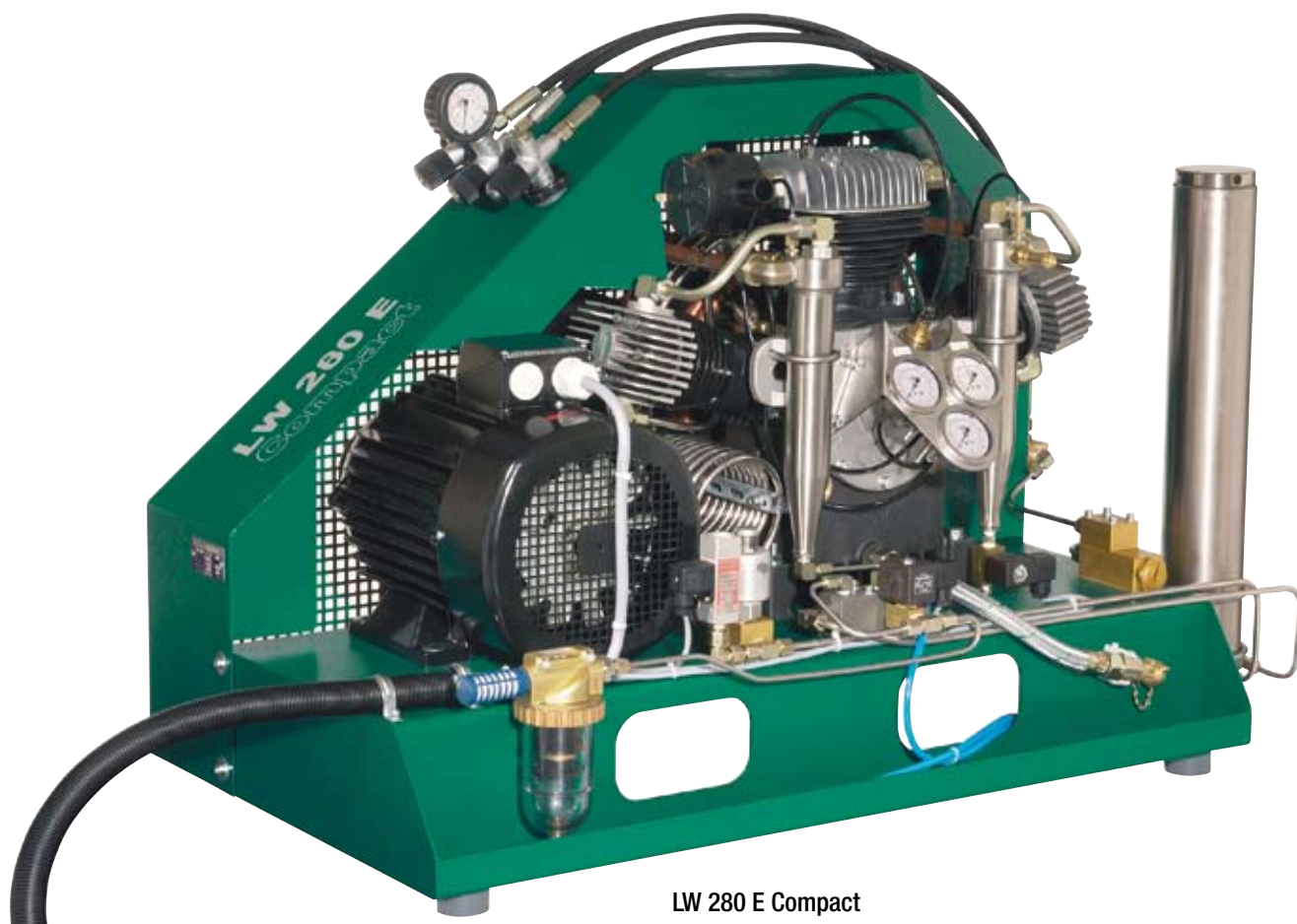

## LW 280 E Compact

With options auto drain, auto stop, oil pressure and inter-stage pressure gauges and 2 extra filling hoses.



# LW 280 E / E1 Compact

Based around the reliable 280 block, this unit has been designed as a basic compressor which can then be customised with optional extras to meet individual requirements or budgets. The compact design also makes it a favourite choice for limited space installations such as on boats. The LW 280 E Compact is supplied with 1 filling hose, up to 3 can be fitted to the unit, or a high pressure outlet for external filling panels.

## Specifications

- >> Fully wired compressor ready to connect with star/delta start cycle, hours counter
- >> Steel base and fan belt guard, powder coated in RAL 6026
- >> All pistons with piston rings
- >> 3 coaxial suction/pressure valves
- >> Low pressure oil pump and filter
- >> Oil/water separators after each stage, safety valve for each stage
- >> Breathing air purification in accordance with EN 12021
- >> Pressure maintaining and non-return valve
- >> 1 Filling hose and filling valve (max. 3 filling hoses and/or HP outlet)

## Options

- >> Additional filling hose(s)
- >> Automatic stop at final pressure
- >> Automatic condensation drain
- >> 200/300 bar switch over device
- >> Motor protection switches
- >> Special voltages/frequencies:
  - 440V 60 Hz (E) / 230V 50Hz (E) / 230V 60Hz (E / E1)
- >> Oil pressure monitoring with auto shut down
- >> Oil pressure gauge and inter stage pressure gauges
- >> Puracon filter monitoring (see page 41)

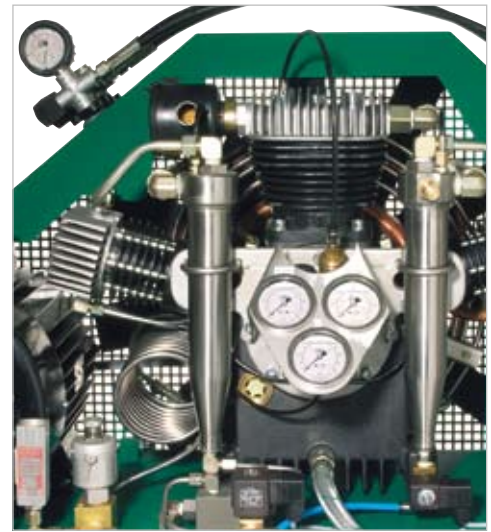

LW 280 E Compact with options

## Technical Data

	LW 280 E Compact	LW 280 E1 Compact
Type:	Air cooled, reciprocating piston compressor	Air cooled, reciprocating piston compressor
Capacity [litre/min] / [Nm <sup>3</sup> /h] / [cfm]:	280 / 16.8 / 9.9	280 / 16.8 / 9.9
Max. Pressure [bar]:	350 (set at the final stage safety valve)	350 (set at the final stage safety valve)
RPM:	1300	1300
No of cylinders / No of stages:	3 / 3	3 / 3
Prime mover type:	3 Phase E-motor 400V / 50Hz	Single Phase E-motor 230V / 50Hz
Drive power [kW] / [HP]:	7.5 / 10.0	7.5 / 10.0
Cooling air requirement [Nm <sup>3</sup> /h]:	2250	2250
Lubrication type:	Oil pump	Oil pump
Oil capacity [litre]:	1.8	1.8
Oil pressure [bar]:	1.8 (+/- 0.3)	1.8 (+/- 0.3)
Air outlet temperature [°C]:	8 - 10°C above ambient	8 - 10°C above ambient
Filter capacity [m <sup>3</sup> at +20°C] <sup>1)</sup> :	900	900
Dimensions L x W x H [cm]:	110 x 60 x 98	110 x 60 x 98
Weight [kg]:	195	205
Noise level [dB]:	83 dB[A] measured at 1 m	83 dB[A] measured at 1 m

<sup>1)</sup> In accordance with EN 12021

# LW 230 E / LW 280 E



LW 280 E with optional ECC control



LW 280 E Rear view

# LW 230 E / LW 280 E

A slow running compressor for medium sized applications. Pneumatic/electric compressor control with final pressure cut off and automatic condensation drain ensure simple and trouble free operation. The 3 stage, 3 cylinder block ensures low maintenance with minimal wear and tear. The components are industrial quality, over dimensioned for ultimate reliability. The compressor is fitted as standard with 4 filling hoses and filling valves to make a complete, compact unit.

## Specifications

- >> Ready to connect compressor, fully wired with pneumatic/electric compressor control with star/delta start cycle
- >> Operating panel with start/stop and condensation test controls, stop button, pressure gauge and hours counter
- >> Automatic condensation drain, pressure free start/stop, leak check function and safety valve check test modes
- >> Automatic shut down when final pressure is reached
- >> Safety cut off if the cover is opened, emergency off switch
- >> Sturdy steel frame, powder coated in RAL 6026
- >> All pistons with piston rings
- >> 3 coaxial suction/pressure valves
- >> Low pressure oil pump and filter
- >> Oil/water separators after each stage, safety valve for each stage
- >> Breathing air purification in accordance with EN 12021
- >> Pressure maintaining and non-return valve
- >> 4 Filling hoses and filling valves and/or HP outlet

## Options

- >> 200/300 bar parallel filling pressures
- >> Motor protection switches
- >> Special voltages/frequencies:  
440V 60 Hz / 230V 50Hz / 230V 60Hz
- >> Oil pressure monitoring with auto shut down
- >> Auto start
- >> Oil pressure gauge
- >> Cylinder temperature with auto shut down
- >> Oil temperature with auto shut down
- >> Inter stage pressure gauges
- >> Puracon filter monitoring (see page 41)

## Technical Data

	LW 230 E	LW 280 E
Type:	Air cooled, reciprocating piston compressor	Air cooled, reciprocating piston compressor
Capacity [litre/min] / [Nm <sup>3</sup> /h] / [cfm]:	230 / 13.8 / 8.1	280 / 16.8 / 9.9
Max. Pressure [bar]:	350 (set at the final stage safety valve)	350 (set at the final stage safety valve)
RPM:	1080	1300
No of cylinders / No of stages:	3 / 3	3 / 3
Prime mover type:	3 Phase E-motor 400V / 50Hz	3 Phase E-motor 400V / 50Hz
Drive power [kW] / [HP]:	5.5 / 7.5	7.5 / 10.0
Cooling air requirement [Nm <sup>3</sup> /h]:	1650	2250
Lubrication type:	Oil pump	Oil pump
Oil capacity [litre]:	1.8	1.8
Oil pressure [bar]:	1.8 (+/- 0.3)	1.8 (+/- 0.3)
Air outlet temperature [°C]:	8 - 10°C above ambient	8 - 10°C above ambient
Filter capacity [m <sup>3</sup> at +20°C] <sup>1)</sup> :	900	900
Dimensions L x W x H [cm]:	110 x 60 x 98	110 x 60 x 98
Weight [kg]:	240	240
Noise level [dB]:	82 dB[A] measured at 1 m	83 dB[A] measured at 1 m

<sup>1)</sup> In accordance with EN 12021

# LW 230 ES / LW 280 ES



LW 280 ES Inner view

LW 280 ES  
with optional ECC control

## The ES Silent Concept

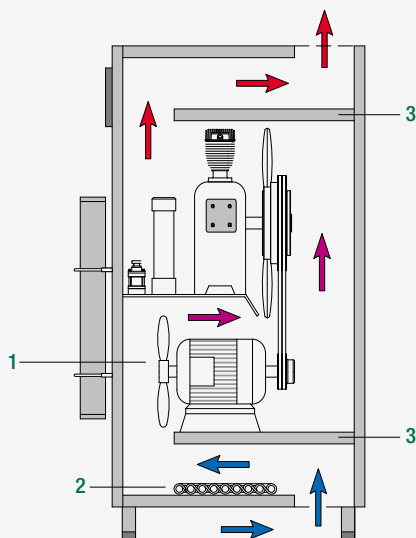

Sound insulation is also heat insulation, manufacturing quiet compressors **and** keeping them cool is the ultimate objective. With the ES concept, we have benchmark sound insulation **and** benchmark cooling. The cross sectional view of the ES housing illustrates the key features.

1. A secondary ventilator provides additional thrust for the cooling air flow through the housing.
2. Additional final stage heat exchangers are the first component in the flow of cooling air into the housing.
3. The intermediate panels with sound insulation padding prevent the direct egress of sound waves out of the housing absorbing the majority of the noise.



# LW 230 ES / LW 280 ES

Excellent compressors with benchmark sound insulation and cooling. The unit has been specially developed for modern day demands. A medium capacity compressor ideally suited for a wide range of applications. The sound insulated housing provides excellent noise suppression so the unit can stand in working or sales rooms or in buildings where noise is not tolerated. The control panel provides a convenient location for up to 6 filling hoses and an overview of the essential compressor controls. The compressor can stand in a corner for space economy, at least two sides must be free.

## Specifications

- >> Ready to connect compressor, fully wired with pneumatic/electric compressor control with star/delta start cycle
- >> Operating panel with start/stop and condensation test controls, stop button, pressure gauge and hours counter
- >> Automatic condensation drain, pressure free start/stop, leak check function and safety valve check test modes
- >> Automatic shut down when final pressure is reached
- >> Emergency-Off switch, safety cut off if the front or rear panels are opened
- >> Sound insulated housing with sturdy steel frame, powder coated in RAL 6026
- >> All pistons with piston rings
- >> 3 coaxial suction/pressure valves
- >> Low pressure oil pump and filter
- >> Secondary fan for extra cooling
- >> Oil/water separators after each stage, safety valve for each stage
- >> Breathing air purification in accordance with EN 12021
- >> Pressure maintaining and non-return valve
- >> 2 self venting filling valves with filling hoses and connections, and/or HP outlet

## Options

- >> Additional filling hose(s)
- >> 200/300 bar parallel filling pressures
- >> Motor protection switches
- >> Special voltages/frequencies:  
440V 60 Hz / 230V 50Hz / 230V 60Hz
- >> ECC controls (see page 40)
- >> Oil pressure monitoring with auto shut down
- >> Cylinder temperature with auto shut down
- >> Auto start
- >> Oil temperature with auto shut down
- >> Inter stage pressure gauges
- >> Puracon filter monitoring (see page 41)

## Technical Data

	LW 230 ES	LW 280 ES
Type:	Air cooled, reciprocating piston compressor	Air cooled, reciprocating piston compressor
Capacity [litre/min] / [Nm <sup>3</sup> /h] / [cfm]:	230 / 13.8 / 8.1	280 / 16.8 / 9.9
Max. Pressure [bar]:	350 (set at the final stage safety valve)	350 (set at the final stage safety valve)
RPM:	1080	1300
No of cylinders / No of stages:	3 / 3	3 / 3
Prime mover type:	3 Phase E-motor 400V / 50Hz	3 Phase E-motor 400V / 50Hz
Drive power [kW] / [HP]:	5.5 / 7.5	7.5 / 10.0
Cooling air requirement [Nm <sup>3</sup> /h]:	1650	2250
Lubrication type:	Oil pump	Oil pump
Oil capacity [litre]:	1.8	1.8
Oil pressure [bar]:	1.8 (+/- 0.3)	1.8 (+/- 0.3)
Air outlet temperature [°C]:	6°C above ambient	6°C above ambient
Filter capacity [m <sup>3</sup> at +20°C] <sup>1)</sup> :	900	900
Dimensions L x W x H [cm]:	76 x 103 x 163	76 x 103 x 163
Weight [kg]:	330	330
Noise level [dB]:	61 dB[A] measured at 1 m	62 dB[A] measured at 1 m

<sup>1)</sup> In accordance with EN 12021

# LW 300 B Nautic

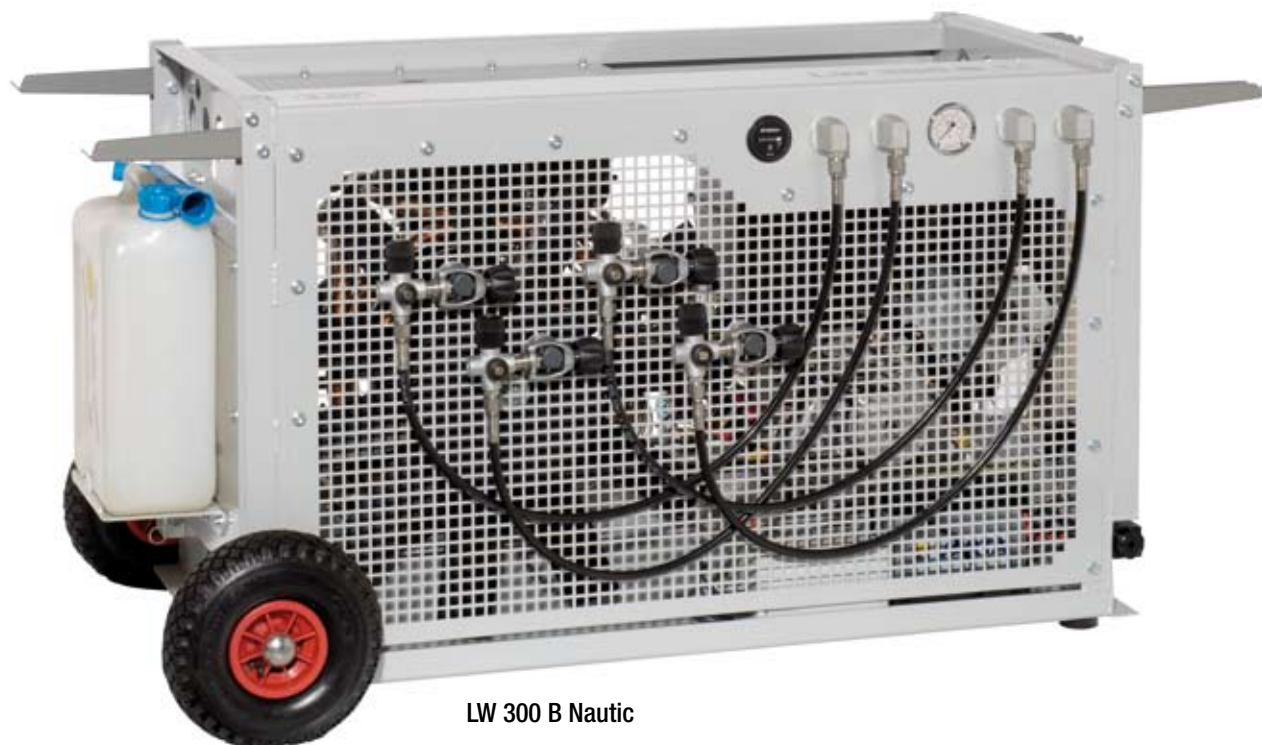

LW 300 B Nautic

Options: Automatic stop and automatic condensation drain, wheel set



LW 300 B Nautic Rear view



# LW 300 B Nautic

For mobile breathing air applications. Lightweight compact design allows stationary performance combined with mobility independent of power supplies. Ideal for multiple application requirements without compromising performance. Operation is simple and the optional semi-automatic controls allows the compressor to work without direct supervision.

## Specifications

- >> Ready to start self contained unit with Vanguard 8.2 kW (11 HP) 4-stroke gasoline engine with electric start
- >> Final pressure gauge and 12V DC hours counter
- >> Sturdy sea water resistant aluminium frame with 4 carrying handles and 4 sling points powder coated in RAL 7004 (silver grey)
- >> 3 cylinder, 3 stage compressor block
- >> All pistons with piston rings
- >> Low pressure oil pump
- >> Oil/water separators after each stage, safety valve for each stage
- >> Breathing air purification in accordance with EN 12021
- >> Pressure maintaining and non-return valve
- >> 4 filling hoses with filling valves and connections, and/or HP outlet

## Options

- >> 200/300 bar parallel filling pressures
- >> Automatic stop and automatic condensation drain
- >> Wheel set
- >> Oil pressure gauge



## Technical Data

	LW 300 B Nautic
Type:	Air cooled, reciprocating piston compressor
Capacity [litre/min] / [Nm <sup>3</sup> /h] / [cfm]:	300 / 18.0 / 10.6
Max. Pressure [bar]:	350 (set at the final stage safety valve)
RPM:	1400
No of cylinders / No of stages:	3 / 3
Prime mover type:	4 stroke gasoline engine, electric start
Drive power [kW] / [HP]:	8.2 / 11.0
Cooling air requirement [Nm <sup>3</sup> /h]:	2460
Lubrication type:	Oil pump
Oil capacity [litre]:	1.8
Oil pressure [bar]:	1.8 (+/- 0.3)
Air outlet temperature [°C]:	8 - 10°C above ambient
Filter capacity [m <sup>3</sup> at +20°C] <sup>1)</sup> :	900
Dimensions L x W x H [cm]:	129 x 74 x 60
Weight [kg]:	180
Noise level [dB]:	95 dB[A] measured at 1 m

<sup>1)</sup> In accordance with EN 12021

# LW 300 E / LW 450 E



LW 450 E



LW 450 E Rear view

# LW 300 E / LW 450 E

Robust, low RPM units with low maintenance and running costs for the user. Pneumatic/electric compressor control with final pressure cut off and automatic condensation drain ensures easy and trouble free operation. The compressors are ideal for continuous operation and a favourite choice for overseas diving centers with very long service intervals [e.g. replacement of coaxial suction/pressure valves (3) every 6000 hours!].

## Specifications

- >> Ready to connect compressor, fully wired with pneumatic/electric compressor control with star/delta start cycle
- >> Operating panel with start/stop and condensation test controls, pressure gauge and hours counter
- >> Automatic condensation drain, pressure free start/stop, leak check and safety valve check test modes
- >> Automatic shut down when final pressure is reached
- >> Safety cut off if the cover is opened, emergency off switch
- >> Sturdy steel frame, powder coated in RAL 6026
- >> All pistons with piston rings
- >> 3 coaxial suction/pressure valves
- >> Low pressure oil pump and filter
- >> Oil/water separators after each stage, safety valve for each stage
- >> Breathing air purification in accordance with EN 12021
- >> Pressure maintaining and non-return valve
- >> 4 Filling hoses and filling valves and/or HP outlet

## Options

- >> 200/300 bar parallel filling pressures
- >> Motor protection switches
- >> Special voltages/frequencies:  
440V 60 Hz / 230V 50Hz / 230V 60Hz
- >> ECC controls (see page 40)
- >> Oil pressure monitoring with auto shut down
- >> Auto start
- >> Oil pressure gauge
- >> Cylinder temperature with auto shut down
- >> Oil temperature with auto shut down
- >> Inter stage pressure gauges
- >> Puracon filter monitoring (see page 41)

## Technical Data

	LW 300 E	LW 450 E
Type:	Air cooled, reciprocating piston compressor	Air cooled, reciprocating piston compressor
Capacity [litre/min] / [Nm <sup>3</sup> /h] / [cfm]:	300 / 18.0 / 10.6	450 / 27.0 / 15.9
Max. Pressure [bar]:	350 (set at the final stage safety valve)	350 (set at the final stage safety valve)
RPM:	800	1100
No of cylinders / No of stages:	3 / 3	3 / 3
Prime mover type:	3 Phase E-motor 400V / 50Hz	3 Phase E-motor 400V / 50Hz
Drive power [kW] / [HP]:	7.5 / 10.0	11.0 / 15.0
Cooling air requirement [Nm <sup>3</sup> /h]:	2250	3300
Lubrication type:	Oil pump	Oil pump
Oil capacity [litre]:	2.2	2.2
Oil pressure [bar]:	1.8 (+/- 0.3)	1.8 (+/- 0.3)
Air outlet temperature [°C]:	8 - 10°C above ambient	8 - 10°C above ambient
Filter capacity [m <sup>3</sup> at +20°C] <sup>1)</sup> :	900	900
Dimensions L x W x H [cm]:	115 x 60 x 98	115 x 60 x 98
Weight [kg]:	280	280
Noise level [dB]:	82 dB[A] measured at 1 m	83 dB[A] measured at 1 m

<sup>1)</sup> In accordance with EN 12021

# LW 300 ES / LW 450 ES



LW 450 ES  
with optional ECC control

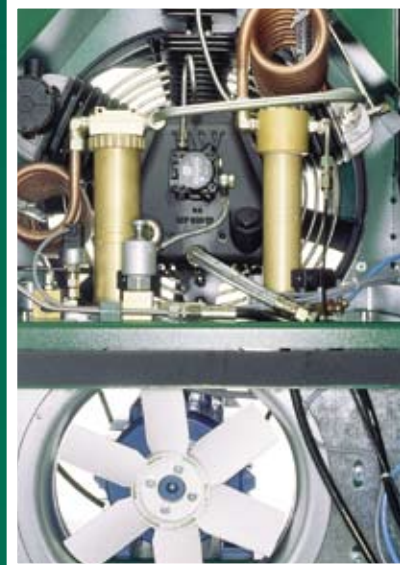

LW 450 ES Inner view

## The ES Silent Concept

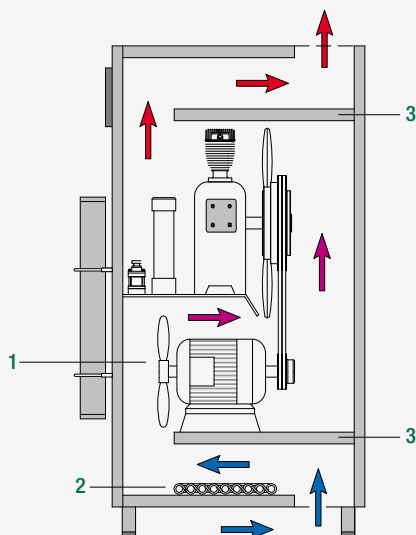

Sound insulation is also heat insulation, manufacturing quiet compressors **and** keeping them cool is the ultimate objective. With the ES concept, we have benchmark sound insulation **and** benchmark cooling. The cross sectional view of the ES housing illustrates the key features.

1. A secondary ventilator provides additional thrust for the cooling air flow through the housing.
2. Additional final stage heat exchangers are the first component in the flow of cooling air into the housing.
3. The intermediate panels with sound insulation padding prevent the direct egress of sound waves out of the housing absorbing the majority of the noise.

# LW 300 ES / LW 450 ES

Our time tested 450 block in a vertical sound insulated housing, sound level only 64 dB[A] at 1 m. Ideal for applications in work areas or mixed industrial/ residential areas (Hotels etc.). A secondary ventilator ensures excellent cooling. The robust, slow running compressor with low maintenance and running costs is fully wired with a pneumatic/electrical compressor control with final pressure cut off and automatic condensation drain ensuring easy and trouble free operation. The compressor can stand in a corner for space economy (min. 2 sides free).

## Specifications

- >> Ready to connect compressor, fully wired with pneumatic/electric compressor control with star/delta start cycle
- >> Operating panel with start/stop and condensation test controls, pressure gauge and hours counter
- >> Automatic condensation drain, pressure free start/stop, leak check and safety valve check test modes
- >> Automatic shut down when final pressure is reached
- >> Emergency off switch, safety cut off if the front or rear panels are opened
- >> Sound insulated housing with sturdy steel frame, powder coated in RAL 6026
- >> All pistons with piston rings
- >> 3 coaxial suction/pressure valves
- >> Low pressure oil pump and filter
- >> Secondary fan for extra cooling
- >> Oil/water separators after each stage, safety valve for each stage
- >> Breathing air purification in accordance with EN 12021
- >> Pressure maintaining and non-return valve
- >> HP outlet

## Options

- >> 4 filling hoses mounted on the front door panel
- >> Motor protection switches
- >> Special voltages/frequencies:  
440V 60 Hz / 230V 50Hz / 230V 60Hz
- >> Oil pressure monitoring with auto shut down
- >> Auto start
- >> Oil pressure gauge
- >> Cylinder temperature with auto shut down
- >> Oil temperature with auto shut down
- >> Inter stage pressure gauges
- >> ECC controls (see page 40)
- >> Puracon filter monitoring (see page 41)

## Technical Data

	LW 300 ES	LW 450 ES
Type:	Air cooled, reciprocating piston compressor	Air cooled, reciprocating piston compressor
Capacity [litre/min] / [Nm <sup>3</sup> /h] / [cfm]:	300 / 18.0 / 10.6	450 / 27.0 / 15.9
Max. Pressure [bar]:	350 (set at the final stage safety valve)	350 (set at the final stage safety valve)
RPM:	800	1100
No of cylinders / No of stages:	3 / 3	3 / 3
Prime mover type:	3 Phase E-motor 400V / 50Hz	3 Phase E-motor 400V / 50Hz
Drive power [kW] / [HP]:	7.5 / 10.0	11.0 / 15.0
Cooling air requirement [Nm <sup>3</sup> /h]:	2250	3300
Lubrication type:	Oil pump	Oil pump
Oil capacity [litre]:	2.2	2.2
Oil pressure [bar]:	1.8 (+/- 0.3)	1.8 (+/- 0.3)
Air outlet temperature [°C]:	8 - 10°C above ambient	8 - 10°C above ambient
Filter capacity [m <sup>3</sup> at +20°C] <sup>1)</sup> :	1200	1200
Dimensions L x W x H [cm]:	81 x 110 x 168	81 x 110 x 168
Weight [kg]:	390	390
Noise level [dB]:	63 dB[A] measured at 1 m	64 dB[A] measured at 1 m

<sup>1)</sup> In accordance with EN 12021



# LW 450 D Basic



LW 450 D Basic

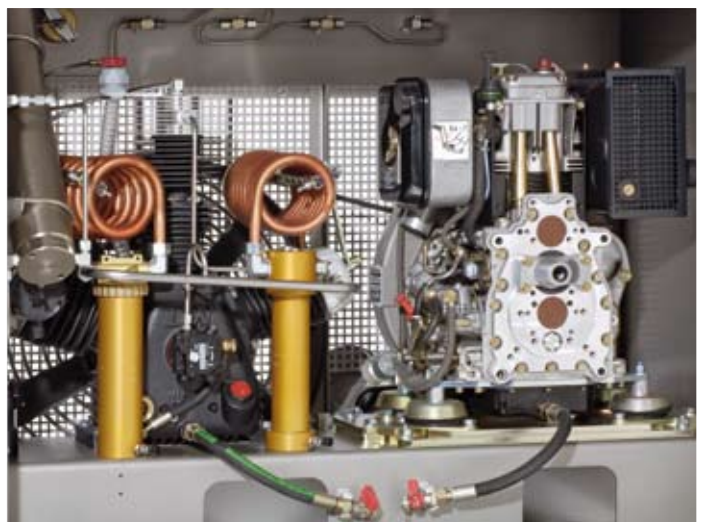

LW 450 D Basic Rear view



# LW 450 D Basic

Initially developed for the open dive boats in the Indian Ocean. Large capacity, slow running, stationary compressor which can be used independent of power supply with diesel drive. The compressor has a stainless steel frame and no electrics and is ideal for extreme applications such as open boats or harsh marine environments.

## Specifications

- >> Self contained unit c/w Hatz 1D81Z, 10.5 kW Motor for hand starting
- >> Original Hatz diesel tank (capacity approx. 2 hours operation)
- >> Manual speed lever, manual stop
- >> Manual condensation drain (3 valves)
- >> Sturdy stainless steel frame
- >> All pistons with piston rings
- >> Low pressure oil pump
- >> Oil/water separators after each stage, safety valve for each stage
- >> Breathing air purification in accordance with EN 12021
- >> Pressure maintaining and non-return valve
- >> 4 filling hoses with filling valves and connections and/or HP outlet

## Options

- >> 200/300 bar parallel filling pressures
- >> Oil pressure gauge
- >> Inter stage pressure gauges

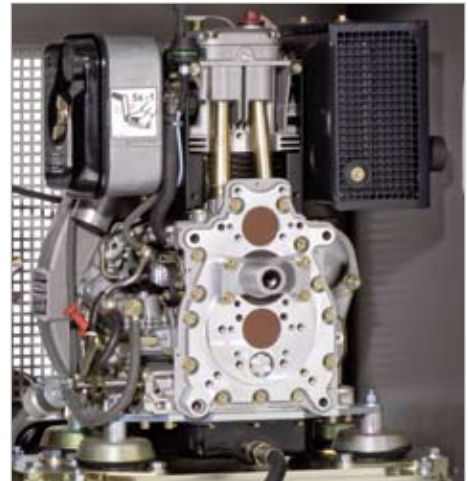

LW 450 D Basic prime mover

## Technical Data

	LW 450 D Basic
Type:	Air cooled, reciprocating piston compressor
Capacity [litre/min] / [Nm <sup>3</sup> /h] / [cfm]:	450 / 27.0 / 15.9
Max. Pressure [bar]:	350 (set at the final stage safety valve)
RPM:	1100
No of cylinders / No of stages:	3 / 3
Prime mover type:	Air cooled diesel, hand start
Drive power [kW] / [HP]:	10.5 / 14.3
Cooling air requirement [Nm <sup>3</sup> /h]:	3300
Lubrication type:	Oil pump
Oil capacity [litre]:	2.2
Oil pressure [bar]:	1.8 (+/- 0.3)
Air outlet temperature [°C]:	8 - 10°C above ambient
Filter capacity [m <sup>3</sup> at +20°C] <sup>1)</sup> :	900
Dimensions L x W x H [cm]:	127 x 74 x 100
Weight [kg]:	400
Noise level [dB]:	95 dB[A] measured at 1 m

<sup>1)</sup> In accordance with EN 12021

# LW 450 D

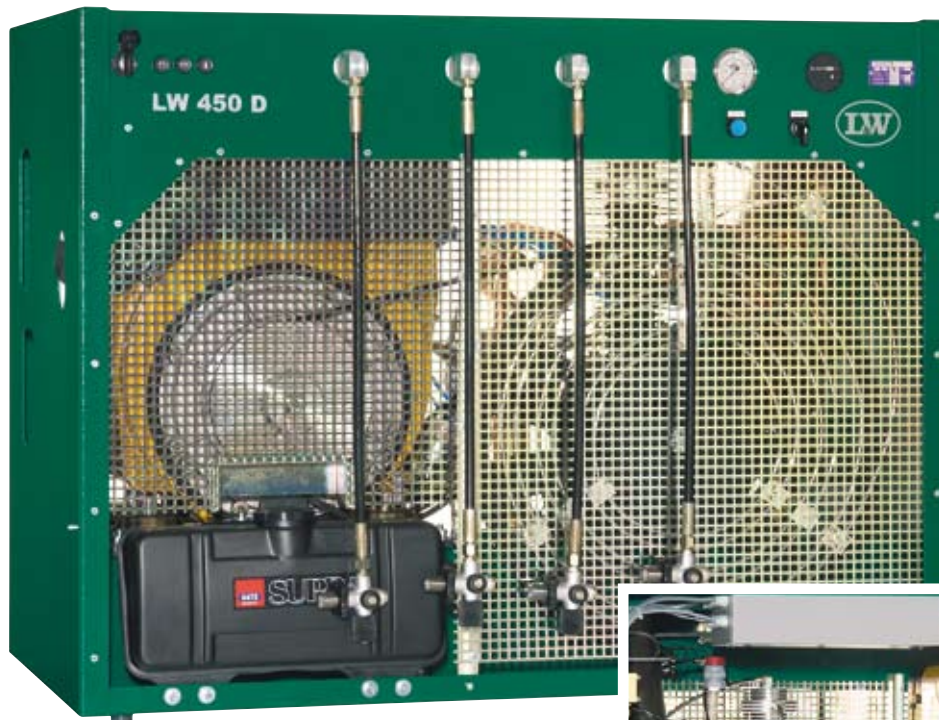

LW 450 D



LW 450 D Rear view

# LW 450 D

For applications where large quantities of air are required without sufficient electrical power supply. Whether on a remote island, a large safari boat or a truck mounted filling station, the LW 450 D is ready for the next challenge. The compressor has a self contained 12V DC power supply providing electric start, idle and full speed selector, automatic idle and condensation drain when final pressure is reached and a condensation test function. The integrated filling unit with 4 filling hoses and filling valves completes the unit.

## Specifications

- >> Self contained unit, ready to start with Hatz 1D81C 10,5 kW Motor in Hatz Silent Pack with 12V electrical/pneumatic compressor control
- >> Original Hatz diesel tank (capacity approx. 2 hours operation)
- >> Operating panel with key start/stop, condensation drain test, pressure gauge, speed selector, hours counter, diesel motor oil pressure and battery warning lamps
- >> Automatic idle speed selector and condensation drain when end pressure is reached (compressor switches to full speed and drain valves close when empty tanks are opened)
- >> Sturdy steel frame, powder coated in RAL 6026
- >> All pistons with piston rings
- >> 3 coaxial suction/pressure valves
- >> Low pressure oil pump
- >> Oil/water separators after each stage, safety valve for each stage
- >> Breathing air purification in accordance with EN 12021
- >> Pressure maintaining and non-return valve
- >> 4 Filling hoses and filling valves and/or HP outlet

## Options

- >> 200/300 bar parallel filling pressures
- >> Oil pressure gauge
- >> Inter stage pressure gauges



LW 450 D Silent Pack

## Technical Data

	LW 450 D
Type:	Air cooled, reciprocating piston compressor
Capacity [litre/min] / [Nm <sup>3</sup> /h] / [cfm]:	450 / 27.0 / 15.9
Max. Pressure [bar]:	350 (set at the final stage safety valve)
RPM:	1100
No of cylinders / No of stages:	3 / 3
Prime mover type:	Air cooled diesel, silent pack, electric start
Drive power [kW] / [HP]:	10.5 / 14.3
Cooling air requirement [Nm <sup>3</sup> /h]:	3300
Lubrication type:	Oil pump
Oil capacity [litre]:	2.2
Oil pressure [bar]:	1.8 (+/- 0.3)
Air outlet temperature [°C]:	8 - 10°C above ambient
Filter capacity [m <sup>3</sup> at +20°C] <sup>1)</sup> :	900
Dimensions L x W x H [cm]:	127 x 74 x 100
Weight [kg]:	430
Noise level [dB]:	89 dB[A] measured at 1 m

<sup>1)</sup> In accordance with EN 12021

# LW 570 E



LW 570 E



LW 570 E Rear view



The 570 series compressors are 4 stage piston compressors for large, professional applications. The 15 kW drive delivers an impressive 570 litres/min (20.1 cfm) and the 4 stage construction allows working pressures of up to 420 bar if required. The slow running compressor guarantees long and reliable service. The unit has been designed for the arduous demands of large filling stations such as city fire departments, large diving schools or hyperbaric facilities.

## Specifications

- > Ready to connect compressor, fully wired with pneumatic/electric compressor control with star/delta start cycle
- >> Operating panel with start/stop and condensation test controls, pressure gauge and hours counter
- >> Automatic condensation drain, pressure free start/stop, leak check and safety valve check test modes
- >> Automatic shut down when the final pressure is reached
- >> Safety cut off if the cover is opened, emergency off switch
- >> Sturdy steel frame, powder coated in RAL 6026
- >> All pistons with piston rings
- >> Low pressure oil pump
- >> 4 coaxial suction/pressure valves
- >> Oil/water separators after each stage, safety valve for each stage
- >> Breathing air purification in accordance with EN 12021
- >> Pressure maintaining and non-return valve
- >> 4 Filling hoses and filling valves with cylinder connections and/or HP outlet

## Options

- >> 200/300 bar parallel filling pressures
- >> Motor protection switches
- >> Special voltages/frequencies:  
440V 60 Hz / 230V 50Hz / 230V 60Hz
- >> ECC controls (see page 40)
- >> Oil pressure monitoring with auto shut down
- >> Oil pressure gauge
- >> Auto start
- >> Cylinder temperature with auto shut down
- >> Oil temperature with auto shut down
- >> Inter stage pressure gauges
- >> Puracon filter monitoring (see page 41)
- >> 420 bar Version

## Technical Data

	LW 570 E
Type:	Air cooled, reciprocating piston compressor
Capacity [litre/min] / [Nm <sup>3</sup> /h] / [cfm]:	570 / 34.0 / 20.1
Max. Pressure [bar]:	420 (set at the final stage safety valve)
RPM:	1100
No of cylinders / No of stages:	4 / 4
Prime mover type:	3 Phase E-motor 400V / 50Hz
Drive power [kW] / [HP]:	15.0 / 20.0
Cooling air requirement [Nm <sup>3</sup> /h]:	4500
Lubrication type:	Oil pump
Oil capacity [litre]:	2.5
Oil pressure [bar]:	1.8 (+/- 0.3)
Air outlet temperature [°C]:	8 - 10°C above ambient
Filter capacity [m <sup>3</sup> at +20°C] <sup>1)</sup> :	1200
Dimensions L x W x H [cm]:	123 x 68 x 100
Weight [kg]:	365
Noise level [dB]:	83 dB[A] measured at 1 m

<sup>1)</sup> In accordance with EN 12021

# LW 570 ES



LW 570 ES with optional ECC control



LW 570 ES Inner view

## The ES Silent Concept

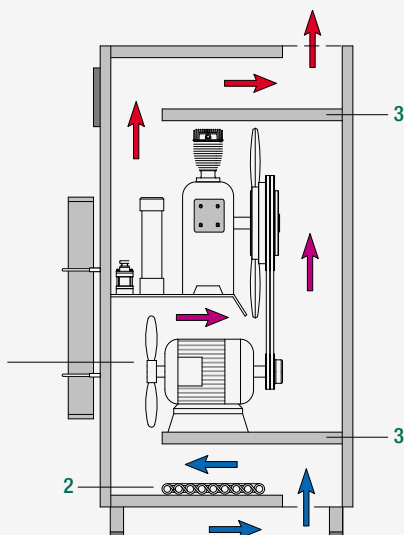

Sound insulation is also heat insulation, manufacturing quiet compressors **and** keeping them cool is the ultimate objective. With the ES concept, we have benchmark sound insulation **and** benchmark cooling. The cross sectional view of the ES housing illustrates the key features.

1. A secondary ventilator provides additional thrust for the cooling air flow through the housing.
2. Additional final stage heat exchangers are the first component in the flow of cooling air into the housing.
3. The intermediate panels with sound insulation padding prevent the direct egress of sound waves out of the housing absorbing the majority of the noise.



The 570 ES is a 4 stage piston compressor for large, professional applications. The unit is housed in a compact sound insulated housing with unprecedented noise emission levels. The 15 kW drive delivers an impressive 570 litres/min (20.1 cfm) and the 4 stage construction allows working pressures of up to 420 bar if required. The slow running compressor guarantees long and reliable service. The unit has been designed for the arduous demands of large volume filling stations in mixed residential/industrial areas, or where people are working and need high performance at low noise levels.

## Specifications

- >> Ready to connect compressor, fully wired with pneumatic/electric compressor control with star/delta start cycle
- >> Operating panel with start/stop and condensation test controls, pressure gauge and hours counter
- >> Automatic condensation drain, pressure free start/stop, leak check and safety valve check test modes
- >> Automatic shut down when the final pressure is reached
- >> Switches cut the compressor off if a door is opened, emergency off switch
- >> Sturdy steel frame and sound isolated housing, powder coated in RAL 6026
- >> All pistons with piston rings
- >> Low pressure oil pump
- >> Two inspection panels for service access
- >> 4 coaxial suction/pressure valves
- >> Oil/water separators after each stage, safety valve for each stage
- >> Breathing air purification in accordance with EN 12021
- >> Pressure maintaining and non-return valve
- >> HP outlet

## Options

- >> 4 filling hoses mounted on the front door panel
- >> Motor protection switches
- >> Special voltages/frequencies:  
440V 60 Hz / 230V 50Hz / 230V 60Hz
- >> ECC controls (see page 40)
- >> Oil pressure monitoring with auto shut down
- >> Auto start
- >> Oil pressure gauge
- >> Cylinder temperature with auto shut down
- >> Oil temperature with auto shut down
- >> Puracon filter monitoring (see page 41)
- >> Inter stage pressure gauges
- >> 420 bar Version

## Technical Data

	LW 570 ES
Type:	Air cooled, reciprocating piston compressor
Capacity [litre/min] / [Nm <sup>3</sup> /h] / [cfm]:	570 / 34.0 / 20.1
Max. Pressure [bar]:	420 (set at the final stage safety valve)
RPM:	1100
No of cylinders / No of stages:	4 / 4
Prime mover type:	3 Phase E-motor 400V / 50Hz
Drive power [kW] / [HP]:	15.0 / 20.0
Cooling air requirement [Nm <sup>3</sup> /h]:	4500
Lubrication type:	Oil pump
Oil capacity [litre]:	2.5
Oil pressure [bar]:	1.8 (+/- 0.3)
Air outlet temperature [°C]:	8 - 10°C above ambient
Filter capacity [m <sup>3</sup> at +20°C] <sup>1)</sup> :	1200
Dimensions L x W x H [cm]:	81 x 110 x 168
Weight [kg]:	505
Noise level [dB]:	64 dB[A] measured at 1 m

<sup>1)</sup> In accordance with EN 12021

# LW 570 D

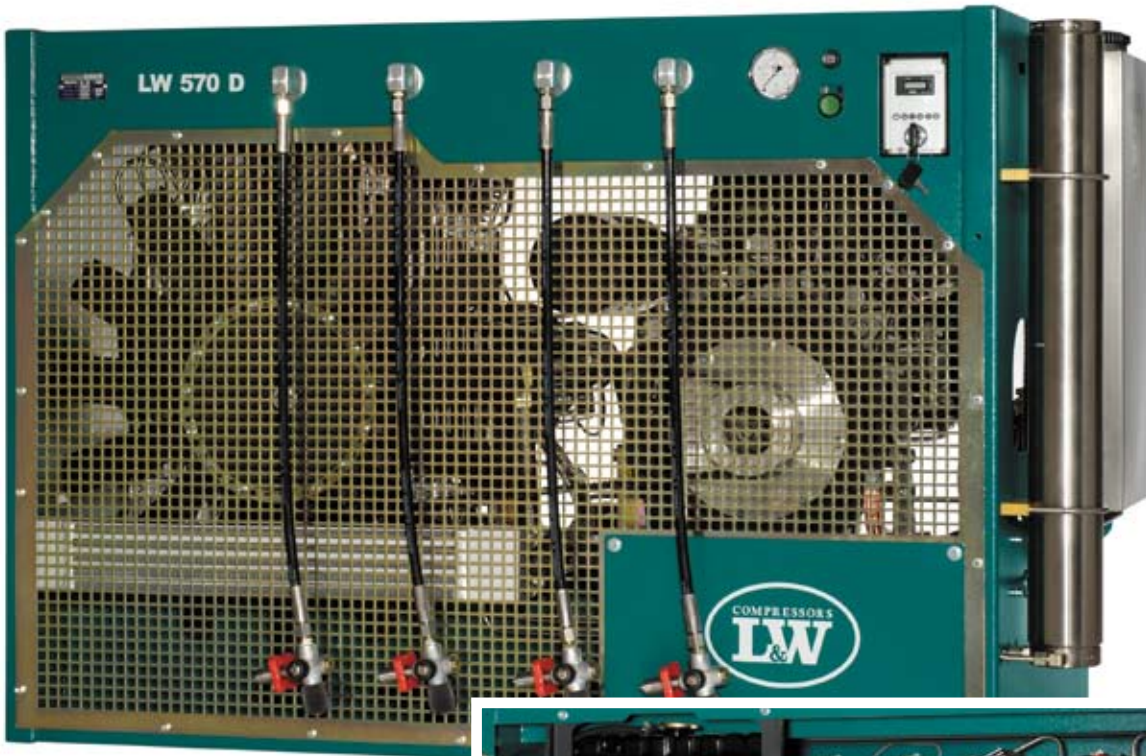

LW 570 D

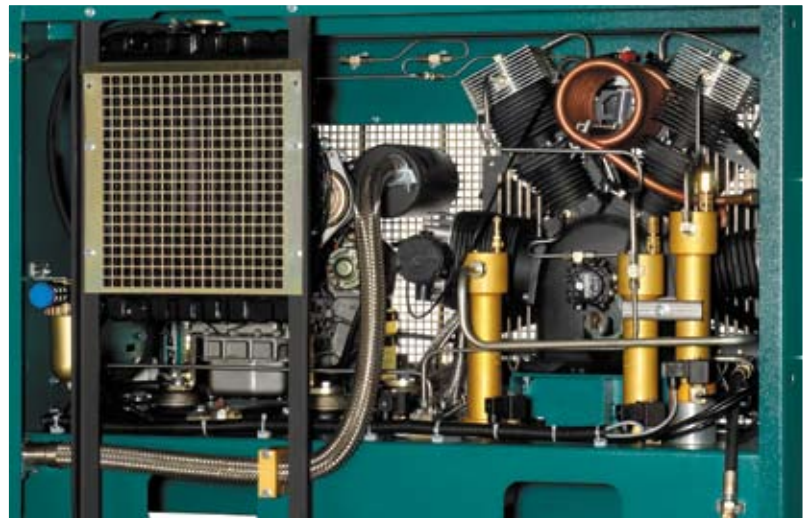

LW 570 D Rear view

The 570 series compressors are 4 stage piston compressors for large, professional applications. The diesel driven unit is no exception but can be operated completely independent of power supply, or where diesel applications are preferred for safety (petro-chemical plants, ground support equipment for aircraft servicing etc.). The heart of the unit is the LW 570 block driven by a water cooled Yanmar 3 cylinder diesel engine. The engine control monitors the condition of the drive and provides vital information for the operator.

## Specifications

- >> Ready to start with 12V compressor controls and an electric start Yanmar 3TNE68 3 cylinder, water cooled diesel engine
- >> Operating panel key start/stop, condensation button (serves as an off loader for starting/stopping, engine oil pressure monitoring, water temperature monitoring, glow plug protection, starter protection, pressure gauge and hours counter
- >> Stainless steel diesel tank, 15.7 litres capacity (approx. 4.5 hours running at full load)
- >> Automatic condensation drain every 15 minutes for 4 seconds
- >> Automatic shut down when the final pressure is reached
- >> Safety cut off if the top cover is opened
- >> Sturdy steel frame, powder coated in RAL 6026, tie down/sling slots integrated in side panels
- >> All pistons with piston rings
- >> Low pressure oil pump
- >> 4 coaxial suction/pressure valves
- >> Oil/water separators after each stage, safety valve for each stage
- >> Breathing air purification in accordance with EN 12021
- >> Pressure maintaining and non-return valve
- >> 4 filling hoses with filling valves and connections, and/or HP outlet

## Options

- >> 200/300 bar parallel filling pressures
- >> Oil pressure gauge
- >> Inter stage pressure gauges
- >> 420 bar Version

## Technical Data

	LW 570 D
Type:	Air cooled, reciprocating piston compressor
Capacity [litre/min] / [Nm <sup>3</sup> /h] / [cfm]:	570 / 34.0 / 20.1
Max. Pressure [bar]:	420 (set at the final stage safety valve)
RPM:	1100
No of cylinders / No of stages:	4 / 4
Prime mover type:	Water cooled 3 cylinder diesel, electric start
Drive power [kW] / [HP]:	12.9 / 17.5
Cooling air requirement [Nm <sup>3</sup> /h]:	3900
Lubrication type:	Oil pump
Oil capacity [litre]:	2.5
Oil pressure [bar]:	1.8 (+/- 0.3)
Air outlet temperature [°C]:	8 - 10°C above ambient
Filter capacity [m <sup>3</sup> at +20°C] <sup>1)</sup> :	1200
Dimensions L x W x H [cm]:	145 x 77 x 100
Weight [kg]:	520
Noise level [dB]:	88 dB[A] measured at 1 m

<sup>1)</sup> In accordance with EN 12021

# LW 720 E

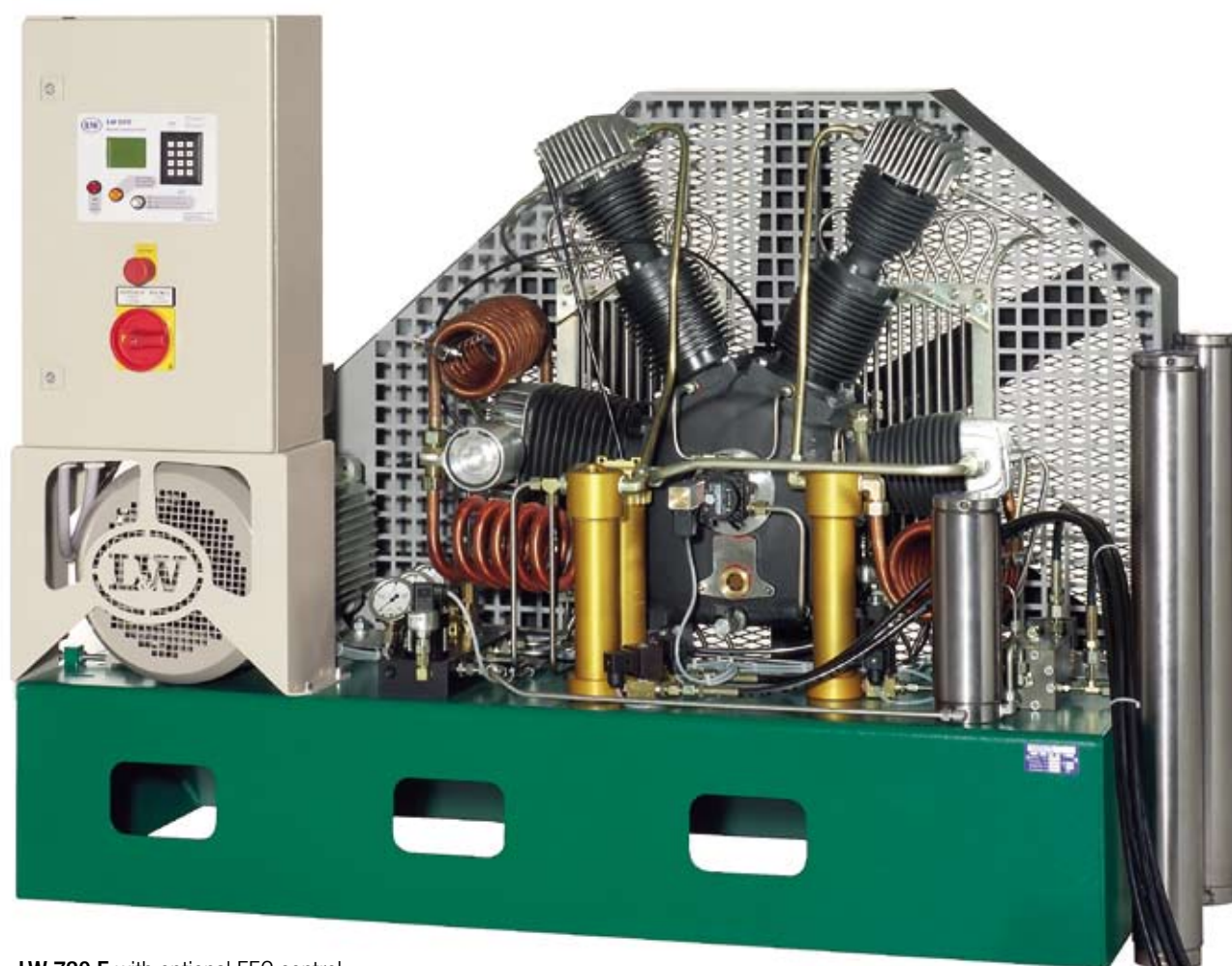

LW 720 E with optional EEC control

Originally designed for heavy duty industrial applications, the LW 720 E 4 stage compressor is built for extreme situations. The compressor block is mounted on sturdy steel frame with easy access to all components. The slow running compressor guarantees long and reliable service. The unit has been designed for the arduous demands of high volume filling stations with an integrated large capacity breathing air purification module included.

## Specifications

- >> Ready to connect compressor, fully wired with pneumatic/electric compressor control with star/delta start cycle
- >> Operating panel with start/stop and condensation test controls, pressure gauge and hours counter
- >> Automatic condensation drain, pressure free start/stop, leak check and safety valve check test modes
- >> Automatic shut down when the final pressure is reached
- >> Emergency off switch
- >> Sturdy steel frame, powder coated in RAL 6026, steel fan guard in RAL 7004
- >> All pistons with piston rings
- >> Low pressure oil pump and filter
- >> Pressure gauge for each stage
- >> Oil pressure monitoring and automatic shut down for low oil pressure
- >> 4 coaxial suction/pressure valves
- >> Oil/water separators after each stage, safety valve for each stage
- >> Breathing air purification in accordance with EN 12021
- >> HP outlet

## Options

- >> Special voltages/frequencies:
  - 440V 60 Hz / 230V 50Hz / 230V 60Hz
- >> ECC controls (see page 40)
- >> Cylinder temperature with auto shut down
- >> Auto start
- >> Oil temperature with auto shut down
- >> Puracon filter monitoring (see page 41)
- >> 420 bar Version

## Technical Data

	LW 720 E
Type:	Air cooled, reciprocating piston compressor
Capacity [litre/min] / [Nm <sup>3</sup> /h] / [cfm]:	720 / 43.2 / 25.4
Max. Pressure [bar]:	420 (set at the final stage safety valve)
RPM:	1100
No of cylinders / No of stages:	4 / 4
Prime mover type:	3 Phase E-motor 400V / 50Hz
Drive power [kW] / [HP]:	18.5 / 25.0
Cooling air requirement [Nm <sup>3</sup> /h]:	5550
Lubrication type:	Oil pump
Oil capacity [litre]:	4.0
Oil pressure [bar]:	1.8 (+/- 0.3)
Air outlet temperature [°C]:	8 - 10°C above ambient
Filter capacity [m <sup>3</sup> at +20°C] <sup>1)</sup> :	2400
Dimensions L x W x H [cm]:	165 x 76 x 125
Weight [kg]:	590
Noise level [dB]:	88 dB[A] measured at 1 m

<sup>1)</sup> In accordance with EN 12021



# LW 1300 E



LW 1300 E

Originally designed for heavy duty industrial applications, the LW 1300 E 4 stage compressor is built for extreme situations. The compressor block is mounted on an extremely sturdy steel frame with easy access to all components. The slow running compressor guarantees long and reliable service. The unit has been designed for the arduous demands of large volume filling stations with a direct drive motor using a cardon coupling.

## Specifications

- >> Ready to connect compressor, fully wired with pneumatic/electric compressor control with star/delta start cycle, electrical box for wall mounting on site
- >> Operating panel with start/stop and condensation test controls, pressure gauge and hours counter
- >> Automatic condensation drain, pressure free start/stop, leak check and safety valve check test mode
- >> Automatic shut down when the final pressure is reached
- >> Emergency off switch
- >> Sturdy steel frame, powder coated in RAL 7004, steel fan guards in RAL 7004
- >> All pistons with piston rings
- >> Low pressure oil pump and filter
- >> Pressure gauge for each stage
- >> Oil pressure monitoring and automatic shut down for low oil pressure
- >> 4 coaxial suction/pressure valves
- >> Oil/water separators after each stage, safety valve for each stage
- >> HP outlet
- >> Breathing air version with external filter panel

## Options

- >> Special voltages/frequencies:
  - 440V 60 Hz / 230V 50Hz / 230V 60Hz
- >> ECC controls (see page 40)
- >> Cylinder temperature with auto shut down
- >> Auto start
- >> Oil temperature with auto shut down
- >> Puracon filter monitoring (see page 41)
- >> 420 bar Version

## Technical Data

	LW 1300 E
Type:	Air cooled, reciprocating piston compressor
Capacity [litre/min] / [Nm <sup>3</sup> /h] / [cfm]:	1300 / 78.0 / 45.9
Max. Pressure [bar]:	420 (set at the final stage safety valve)
RPM:	985
No of cylinders / No of stages:	4 / 4
Prime mover type:	3 Phase E-motor 400V / 50Hz, direct drive
Drive power [kW] / [HP]:	37.0 / 50.0
Cooling air requirement [Nm <sup>3</sup> /h]:	11100
Lubrication type:	Oil pump
Oil capacity [litre]:	4.8
Oil pressure [bar]:	1.8 (+/- 0.3)
Air outlet temperature [°C]:	8 - 10°C above ambient
Filter capacity [m <sup>3</sup> at +20°C] <sup>1)</sup> :	3600
Dimensions L x W x H [cm]:	159 x 121 x 126
Weight [kg]:	980
Noise level [dB]:	89 dB[A] measured at 1 m

<sup>1)</sup> In accordance with EN 12021

# Electronic Compressor Control

The L&W ECC (electronic compressor control) is available for all electric motor driven compressors from LW 230 and larger. The ECC replaces the standard electric/pneumatic control and offers the user a range of functions and interfaces only available with digital controls. The unit has an illuminated LCD display which can show various functions and values as selected on the numeric key board. An easy to follow menu accompanies the user through the menu points. The ECC software can be updated using a standard windows computer via the RS232 serial cable. The ECC is available in metric or imperial versions and in German, English, French, Spanish, Dutch and Swedish languages.

## Specifications

- >> Automatic condensation drain
- >> Full automatic mode (auto start and auto stop)
- >> Semi automatic mode (auto stop)
- >> Log book function with hours run, number of starts and max pressure
- >> Elapsed filling time (minutes)
- >> Final pressure
- >> 3 control LEDs for power on, compressor on, compressor off.
- >> Dual filling pressure display (for 200/232 and 300 bar compressors)
- >> Error warnings (e.g. „door is open“)
- >> Maintenance programme with hours countdown and required part numbers in display
- >> Test mode for leak check, safety valve test and solenoid test
- >> Interface for final pressure signal to external siren/light
- >> Interface for error signal to external siren/light

## Options

- >> PIN number lock (prevents unauthorised compressor use)
- >> Oil temperature display and auto cut off
- >> Oil pressure switch and auto cut off
- >> Oil pressure display with auto cut off
- >> Cylinder head temperature display and auto cut off
- >> Ambient temperature monitoring  $< +5^{\circ}\text{C}$  and/or  $> +50^{\circ}\text{C}$  with auto cut off/start inhibitor
- >> Inter stage pressure monitoring (available for 3 and 4 stage compressors)
- >> Puracon interface with „change filter“ alarm in LCD display
- >> Motor overload protection switch with message in LCD display
- >> Inlet pressure monitoring with auto cut off
- >> Compressor block heating for operations  $< +5^{\circ}\text{C}$



# Puracon Moisture Controller

Monitors high pressure air after filtration and indicates the water content in  $\text{mg}/\text{m}^3$ . The Puracon can be used to monitor filter cartridge condition and informs the user when the filter needs changing. Serves as quality assurance for product liability for air filling stations avoids filter cartridge life calculations according to hours run and temperature redundant and provides assurance for clean air in oxygen mixing applications (Nitrox/Trimix).

The Puracon can be mounted anywhere in the pipeline after the filter and a non return valve (to prevent pressure surges). Because the Puracon is mounted after the filter housing, no modifications are necessary to an existing filter and standard cartridges are utilised.

## Specifications

- >> Display Unit, 120 x 120 x 60 mm for wall mounting with power supply cable and plug (1.2 m length) and sensor cable (2 m length)
- >> Stainless steel sensor housing ( $\varnothing$  45 x 95 mm) with 2 x G $\frac{1}{4}$ " inlet/outlet and cable socket
- >> Non-wasting sensor
- >> Digital LCD display language can be selected in English, German, Spanish & French, showing water content in  $\text{mg}/\text{m}^3$
- >> 3 programmable quick reference LEDs for Filter status (green, yellow and red) default settings:  
Green: < 20  $\text{mg}/\text{m}^3$ , Yellow: 20-25  $\text{mg}/\text{m}^3$ , Red: > 25  $\text{mg}/\text{m}^3$  (switch for compressor cut off)
- >> Max Working pressure 350 bars
- >> Blank screw for inserting into housing during sensor service
- >> Interface for automatic cut off of the compressor if desired
- >> Instruction manual

## Versions available

- >> 230 V AC
- >> 12 V DC
- >> Ex with ATEX certification



# LW Air Cooler +3°C

Filter capacity and filter life, an important theme with financial implications for professional filling stations where cost control is vital. The life of a filter is strongly influenced by the running temperature of the compressor and ambient temperature.

Example: LW 450 E at +20°C outlet temperature has a filter life of approx. 33 hrs, at +35°C this time is reduced to just 10 hours! If the air is cooled down to +3°C after the final compression stage before it enters the final separator, the life of the filter cartridge can be extended up to 6 times, in extreme tropical conditions 10 times! The L&W refrigeration dryers, named Air Coolers, can pay for themselves within 1 season in saved filter cartridge costs. To monitor the exact state of the filter and register when the cartridge needs changing, we recommend the L&W Puracon moisture controller (page 41).

For some industrial applications, the air cooler can provide suitable drying without the need for filters.

The coolers are available as independent units with water separators, automatic condensation drain with timer and silencer, or as the economical.

LW Air Cooler BASIC for connection to a compressor with final stage oil/water separator and drain.

## Specifications

- >> Ready to connect with oil/water separator automatic condensation drain and silencer (Basic version without separator, drain and silencer)
- >> Digital temperature display in °C
- >> Steel housing, powder coated in RAL 6026
- >> Power supply cable for 230V 50Hz connection and CE plug (60Hz versions available)

LW Air Coolers are available in 2 pressure ratings, max 250 bars and max. 350 bars. The basic units have a max. working pressure of 450 bar. The units up to and including 2850 litres/min capacity are for wall mounting, the larger units are free standing. The units are maintenance free with environment friendly CFC-free refrigeration fluids.



LW AC 450-900

## Technical Data

Model	Max. flow [m³/h] / [l/min]	Working pressure [bar]	Power consumption [kw]	Cooling air requirement [m³/h]	Mount case	Refrigeration fluid	W x D x H [mm]	Weight [kg]
LW AC 450 Basic	27 / 450	420	0.5	390	wall mount	R 134a	330 x 250 x 700	38
LW AC 450	27 / 450	250 / 350	0.5	390	wall mount	R 134a	330 x 250 x 700	38
LW AC 900 Basic	54 / 900	420	0.6	570	wall mount	R 404 a	330 x 250 x 700	48
LW AC 900	54 / 900	250 / 350	0.6	570	wall mount	R 404 a	330 x 250 x 700	48
LW AC 1350 Basic	81 / 1350	420	0.9	900	wall mount	R 404 a	500 x 430 x 840	72
LW AC 1350	81 / 1350	250 / 350	0.9	900	wall mount	R 404 a	500 x 430 x 840	72
LW AC 1950	117 / 1950	250 / 350	1.1	1140	wall mount	R 404 a	500 x 430 x 840	84
LW AC 2850	171 / 2850	250 / 350	1.4	1800	wall mount	R 404 a	500 x 430 x 840	98
LW AC 3650	219 / 3650	250 / 350	2.2	2200	free standing	R 404 a	800 x 670 x 1350	164
LW AC 5400	324 / 5400	250 / 350	3.6	3400	free standing	R 404 a	800 x 670 x 1350	196
LW AC 7000	420 / 7000	250 / 350	4.3	4200	free standing	R 404 a	800 x 670 x 1350	224



These panels, although primarily for breathing air purification, can be used for various gas filtration requirements. The high pressure filter housings are certified and documented in accordance with current pressure vessel regulations to a maximum working pressure of 350 bar (5250 psi) and 420 bar (6200 psi).

The assembly is mounted on a sturdy wall panel and piped ready for connection with a pressure maintaining and non-return valve. If required, the inlet can be secured with a pressure relief valve. These panels are the preferred choice for filtration remote from the compressor and are ideal for multiple compressor installations especially when using a central refrigeration dryer, or for upgrading an outdated filter system.

The filter housings are available in two sizes, 1.7 and 2.3 litre volume and in single, double or triple combinations. Cartridges are available for breathing air, breathing air with additional CO/CO<sub>2</sub> removal, drying, active charcoal, natural gas drying, and more.

## Specifications

- >> Steel frame and housing, powder coated in RAL 6026
- >> Pressure maintaining and non-return valve, 8 mm outlet
- >> Inlet 8 mm
- >> Nickel plated steel filter housing(s) with 1 drain tap on each panel

## Options

- >> Safety valve
- >> Puracon filter monitoring (see page 41)
- >> Filter cartridges (see page 56-57)



## Technical Data

Filter panel	Capacity breathing air at +20°C [m³]	W x H x D [mm]	Weight [kg]	Max WP [bar]
1 x 1.7 litre	900	270 x 570 x 180	27	350
2 x 1.7 litre	1800	430 x 570 x 180	44	350
3 x 1.7 litre	2700	560 x 570 x 180	61	350
1 x 2.3 litre	1200	270 x 815 x 180	32	350
2 x 2.3 litre	2400	430 x 815 x 180	54	350
3 x 2.3 litre	3600	560 x 815 x 180	76	350
1 x 2.3 litre	1200	270 x 815 x 180	38	420
2 x 2.3 litre	2400	430 x 815 x 180	67	420
3 x 2.3 litre	3600	560 x 815 x 180	95	420

# Storage Cylinders

Storage tanks are frequently used to provide extra filling capacity during peak periods. The storage cylinders can either be opened „all at once“ in a single stage, or „cascaded“ into the cylinders to be filled, usually in 3 stages. Ideally the storage pressure should be higher than the filling pressure, 300 bar storage systems are the most common. The storage systems can be used with most compressors and are best suited for automatic operation (e.g. ECC or auto start option). L&W has a full range of storage modules each of which can be combined with other modules for individual configuration.

## Specifications

- >> Steel tanks with 10 year hydro test, powder coated in accordance with EN 1089/3
- >> Working pressure: 200, 300, 350 or 420 bar
- >> Sturdy steel frame, powder coated in RAL 6026
- >> Standard volume 50 litre
- >> Connected according to customer's specifications
- >> Modular construction to accomodate future expansions



## Technical Data

Cylinders	Capacity [m <sup>3</sup> ]	W x H x D [cm]	Weight [kg]
<b>300 bar storage PW 300 bar / PH 450 bar</b>			
1 x 50 litre	15	25 x 178 x 30	125
2 x 50 litre	30	50 x 178 x 30	210
3 x 50 litre	45	75 x 178 x 30	310
4 x 50 litre	60	100 x 178 x 30	405
6 x 50 litre	90	Ø 80 x 195	570

# Auto Filling Selector

Auto filling selectors provide the ideal solution for simple and effective storage management. These units co-ordinate the flow of air in the filling station automatically between the compressor, the storage and the filling panel. The user simply connects the empty cylinders to the filling panel and opens the cylinder valves.

The compressor, storage and auto filling selector can be located remotely from the filling panel with only one HP line between the auto filling selector and the filling panel.

In addition to simplified filling operations, the auto filling selectors also save energy and time making the filling operation more economical. Once the compressor is switched on, it will not switch off until all the cylinders that are connected on the filling panel are filled and the storage bank is refilled to maximum working pressure. The compressor runs continuously during the entire filling operation and therefore more efficiently.

## The auto filling selectors are available in 3 versions



### Pneumatic

For applications where the storage pressure is at least 30 bar above the max filling pressure on the filling panel and a pressure reducing station is already available between the storage and the filling panel.  
30 x 27 x 10 cm, 3 kg

### Pneumatic with integrated pressure reducing station

For applications where the storage pressure is at least 30 bar above the max filling pressure on the filling panel and a pressure reducing station is also required to safely reduce and secure the pressure from storage to filling pressure.

55 x 35 x 15 cm, 9 kg



### Pneumatic-electronic

For applications where the storage pressure is the less than 30 bar higher than the max. filling pressure on the filling panel.

43 x 26 x 10 cm, 16 kg

### Options

>> Auto start signal for the compressor

# Manual Storage Management

Manual storage management is the most economical solution for storage management. The storage cylinders are either piped together with one line leading to the storage management panel/filling panel (single stage storage) or the cylinders are piped individually or in so called banks, generally either 2, 3 or 4 stages (cascade storage). A separate line is necessary from each storage stage to the cascade management panel.



## Single stage storage management

The simplest form of storage management. Available either as a separate panel (see technical data below) to add to an existing filling station or as an option built into a filling panel.

### Operation

The cylinders to be filled are connected to the filling panel and the filling/cylinder valves are opened. The storage is manually opened until the pressure has equalised or the filling pressure in the filling panel is reached. The storage valve is then turned off and the cylinders can be topped up using the compressor. When all the cylinders on the filling panel are full, the storage can be opened manually and refilled using the compressor.

## Cascade panels

Cascade filling panels are particularly efficient for smaller quantities of cylinders or where a maximum number of fills is desired without using the compressor (i.e. during silent periods). The separate panels can be added to an existing filling station. They should be mounted immediately before the filling panel for easy access and operation.

### Specifications

- >> Steel frame and housing, powder coated in RAL 6026
- >> Available in 1, 2, 3 or 4 stage versions
- >> Ø 63 mm 0-400 bar glycerine filled pressure gauge for each stage
- >> Hand wheel isolation valve for each stage
- >> 8 mm bulkhead fittings (left), 1 for each stage and 1 for the compressor
- >> 8 mm bulkhead fitting (right) outlet to the filling panel
- >> Ready to connect, fully piped with stainless steel piping



3 stage cascade management panel

### Operation

The cylinders to be filled are connected to the filling panel and the filling/cylinder valves are opened. The storage is manually opened starting with the storage stage with the lowest pressure (must be above the remaining pressure in the cylinders) until the pressure has equalised or the filling pressure in the filling panel is reached. This is repeated working up the storage stages until the final stage (the highest pressure) is opened. The storage valve is then turned off and the cylinders can be topped up using the compressor. When all the cylinders on the filling panel are full, the storage can be opened manually, either all together or stage by stage starting with the highest pressure, and are refilled using the compressor. The storage stages need to be closed before the next filling cycle starts.

## Technical Data

Order no	No of stages	W x D x H [cm]	Weight [kg]
002957	1	21 x 23 x 33	6.5
002935	2	39 x 23 x 33	10
002329	3	58 x 23 x 33	13
002816	4	78 x 23 x 33	16

# Air Station

A breathing air filling station specifically designed for outdoor applications allowing air cylinders to be filled outside of shop hours and/or without involving staff. The filling station is housed in a weather proof stainless steel housing for wall mounting, this cabinet has a standard cylinder lock in the door.

Payment is processed using programmable magnetic keys which are issued to customers and a credit "loaded" on to the key. The digital display indicates the remaining credit on the key as the filling process takes place.

The filling station is equipped with an easy to use, self venting lever filling valve which can control up to 4 filling hoses. The filling hoses are equipped with the L&W patented anti-whip DIN safety ends or yoke connections. The venting is inside the housing and suppressed with a silencer reducing noise to a minimum, especially important for "out of hours" use.

The air station is easy to use, the key is placed in the holder and a start/stop switch controls the fill. The unit has an automatic final pressure shut-off and a safety valve for the final pressure. The storage pressure that supplies the air station and the filling pressure are shown on 2 pressure gauges. An emergency switch provides an additional safety feature.

The units comes complete with an interface for crediting and/or analysing the magnetic keys, including a cable to a serial 9-pole PC port. The software (included) will run on a windows PC. The data port is a serial 9 pole RS 232 port.

## Specifications

- >> Lockable, all weather stainless steel housing
- >> Type tested final pressure safety valve (225 bar)
- >> Two pressure gauges (0-400 bar, Ø 63 mm, class 1.6)
- >> Choke for controlling the air flow to 800 litre/min
- >> LCD Display, 2 LED control lights
- >> Automatic final pressure shut off
- >> Stainless steel filling hose holder
- >> High pressure piping, stainless steel
- >> 8 mm bulkhead fitting for air inlet
- >> Central lever filling valve, self venting
- >> Silenced venting inside the housing
- >> 1, 2, 3 or 4 Filling hoses with certificate, length: 1000 mm (other lengths available on request)
- >> DIN 200 bar non-whip safety DIN, or yoke connections
- >> Start, Stop & Reset buttons, emergency off switch
- >> Filling instructions and complete documentation templates

## Option: Removable memory module

- >> Separate lockable cabinet housed inside the stainless steel cabinet contains "plug-in" memory unit that stores the data from the air station.
- >> Data can then be downloaded via RS232 port for storage and analysis.
- >> Ideal for remote air stations where the owner/operator makes regular control visits.



## Technical Data

Filling pressure [bar]	Inlet pressure [bar]	Filling rate [litre/min.]	Power supply	W x H x D [mm]	Weight [kg]
200, 232 or 300	max. 350	800 (+/- 5%)	230V AC, 50 Hz, approx. 15 Watt	600 x 760 x 210	42



# Filling Panels

The wide range of L&W filling panels has established itself as an industry benchmark for optimum design with an extensive list of features. The modular design guarantees that filling stations can be extended to adapt to your future requirements. The panels are available with either 200, 232 or 300 bar filling pressure (3000/4500 psi) or as dual pressure filling panels for simultaneous filling without the need to select the pressure. The self venting lever operated filling valves are available with either filling hoses and connections or direct filling connections for BA cylinders. We have a wide range of filling connections available (see page 55). A unique feature of the L&W panels is the facility to swing open the housing for maintenance work, without any disconnections, a leak check can be carried out while the panel is open.



**4 point panel - 2 x 200 bar, 2 x 300 bar with hoses and DIN anti-whip connections**

## Specifications

- >> Sturdy steel frame, removable for easy mounting, powder coated in RAL 6026
- >> Steel plate housing powder coated in RAL 6026
- >> 8 mm bulkhead fitting for air inlet (inter-changeable left/right)
- >> Ready for connection, piped with 8 mm stainless steel piping
- >> Start/Stop remote control with running control lamp (available for various compressor controls)
- >> Large Ø 100 mm pressure gauge for each filling pressure
- >> Self-venting lever filling valves (venting within the housing for noise reduction). Valves can be equipped with extra silencers for further noise reduction
- >> Filling hoses or direct BA connections according to your specifications
- >> Large Ø 100 mm pressure gauge(s)
- >> Self-venting lever filling valves
- >> Panels for dual pressure equipped

## Filling panels with filling hoses

- >> 1000 mm HP hoses with stainless steel fittings (longer hoses available)
- >> Filling connections (see page 55) anti-whip option recommended for DIN or NF connections

## Filling panels with direct BA connections

- >> Direct BA connections for flanging the cylinders on to the panel
- >> Filling connections (see page 55) anti-whip option recommended for DIN or NF connections
- >> Dust caps and holders for DIN connections

## Options available

- >> L&W anti-whip safety connections for DIN/NF connections
- >> Silencers for further reducing venting noise
- >> Storage inlet/outlet with hand wheel valve and pressure gauge (see page 46)
- >> Pressure reducer and safety valve in the inlet for 300 bar storage and only 200 bar filling
- >> 8 mm bulkhead outlet for additional filling panels (modular system)



6 point panel - 2x200, 4x300 bar direct BA connections

## Stainless Steel Filling Panels

Ideal for installations in marine environments (beach locations, live aboard boats, etc.) where corrosion is a large problem.

The stainless steel panels have the same features as the standard filling panels except they are fully equipped with stainless steel fittings and mountings.



## Technical Data

1 Filling pressure	L x W x H [cm]	Weight [kg]
1-point	21 x 23 x 33	6.5
2-point	39 x 23 x 33	9.0
3-point	58 x 23 x 33	12
4-point	80 x 23 x 33	15
6-point	115 x 23 x 33	20
8-point	153 x 23 x 33	25
9-point	172 x 23 x 33	28

2 Filling pressures	L x W x H [cm]	Weight [kg]	Configurations
4-point	82 x 23 x 33	18	1+3, 2+2, 3+1
6-point	118 x 23 x 33	23	1+5, 2+4, 3+3, 4+2, 5+1
8-point	156 x 23 x 33	28	1+7, 2+6, 3+5, 4+4, 5+3, 6+2, 7+1
9-point	175 x 23 x 33	31	1+8, 2+7, 3+6, 4+5, 5+4, 6+3, 7+2, 8+1

# Nitrox / Trimix

Nitrox or EAN (enriched air nitrox) is a widely accepted alternative to diving with air and offers various advantages. Trimix is a term referring to gas mixtures containing helium for deep diving.

L&W offers two alternatives for Nitrox filling stations.

Partial pressure blending panels require a supply of medical grade oxygen and safely control the flow of oxygen together with oxygen compatible air (OCA) into an oxygen clean diving cylinder. The panels have the advantage of low investment and zero energy consumption and are the ideal investment for Nitrox filling stations who have a reliable supply of oxygen with small or moderate filling requirements. The blending panels can also be used for mixing Trimix mixtures in diving cylinders.

Despite the higher investment and higher energy consumption, membrane nitrox generators are the indispensable choice for filling stations where there is no reliable supply of oxygen. This method of nitrox generation and filling is ideal for large volume diving centres where the membrane operation in conjunction with a suitable high pressure compressor is simple and quick.

L&W cannot endorse the use of continuous blending systems due to the potential risk of mixtures greater than 40% oxygen entering the high pressure compressor.

## Alpha 1 Oxygen Analyser

Hand held oxygen analyser ideal for analysing oxygen content in any location.

The robust metal housing which includes the oxygen sensor and the water-proof (IP65) construction make this analyser a first choice for diving schools, instructors and divers alike.

The Alpha 1 is standard with the pro panel and Mixmaster panels and available as an option with the classic panel.

## Features

- >> Cast metal housing sealed with rubber gaskets, IP65 protection
- >> Large stainless steel eye for lanyard/hook
- >> Fine calibration with hand wheel, secondary calibration inside
- >> User replaceable 9V battery (display goes faint to indicate battery change due)
- >> Sensor inlet sealed with screw cap and O Ring for water protection and conserving sensor life
- >> User replaceable sensor, expected life approx. 3 years
- >> Measuring range 1-100% oxygen
- >> 0.1% accuracy



# Nitrox Membrane Systems

Nitrox membrane systems are based around a special semi-permeable „filter“ called a membrane. The membrane is fed with very clean, low pressure air. The air is separated between oxygen and nitrogen within the membrane leaving a higher percentage of oxygen (> 28 - 40%) in the gas that exits the sides of the membrane, and a higher percentage of nitrogen (> 90 - 99%) exiting the top of the membrane.

The capacity of the membrane is the amount of nitrox produced. This is then compressed in a suitable HP compressor, the quantity of nitrox must be higher than the delivery rate of the HP compressor due to some loss within the HP compressor.

The membrane therefore has a degree of waste (the nitrogen) so that the amount of air entering the membrane is considerably higher than the nitrox exiting the membrane. This air requirement is the most important factor when sizing either the high pressure storage or the low pressure compressor that feeds the membrane and increases drastically with an increase in oxygen percentage of the nitrox.

L&W membranes are available in two sizes S & L. The L membranes can also be mounted in parallel to produce even higher quantities of nitrox if required (> 800 litre/min).

## Technical Data S membrane

Inlet pressure	Oxygen %						
	28%	30%	32%	34%	36%	38%	40%
<b>Technical Data S membrane outlet capacity (litre/min) at +20°C</b>							
4 bar	128	131	134	137	140	143	-
5 bar	163	167	170	174	178	181	185
6 bar	199	203	207	212	216	221	225
7 bar	235	240	246	251	256	261	267
8 bar	273	279	285	291	297	303	309
9 bar	311	318	325	332	339	346	353
10 bar	351	358	366	374	382	390	397
11 bar	391	400	408	417	426	435	443
<b>Technical Data S membrane air inlet requirement (litre/min) at +20°C</b>							
4 bar	177	206	242	299	392	557	-
5 bar	225	256	296	357	444	580	998
6 bar	274	311	361	417	526	662	991
7 bar	324	368	427	494	597	745	1066
8 bar	376	426	495	573	692	864	1190
9 bar	429	487	565	654	793	985	1340
10 bar	484	550	627	741	897	1130	1569
11 bar	543	615	715	830	1022	1304	1869

This data is based on a membrane air inlet temperature of +20°C. Temperatures below +20°C increase the selectivity of the membrane and the capacity and the air requirement is reduced, temperatures above +20°C increase the permeability of the membrane and the capacity and the air inlet requirement increases.

## Technical Data L membrane

Inlet pressure	Oxygen %						
	28%	30%	32%	34%	36%	38%	40%
<b>Technical Data L membrane outlet capacity (litre/min) at +20°C</b>							
4 bar	250	256	262	268	274	280	-
5 bar	318	325	333	341	348	356	364
6 bar	387	396	406	415	425	434	443
7 bar	458	470	481	492	503	514	515
8 bar	532	545	558	571	584	596	609
9 bar	607	622	637	652	666	681	696
10 bar	685	701	718	735	751	768	784
11 bar	764	783	801	820	838	857	875
<b>Technical Data L membrane air inlet requirement (litre/min) at +20°C</b>							
4 bar	345	401	472	585	768	1093	-
5 bar	438	500	579	698	871	1139	1964
6 bar	534	608	706	818	1027	1302	1950
7 bar	633	718	836	969	1172	1465	2101
8 bar	734	833	970	1124	1360	1700	2346
9 bar	838	952	1108	1284	1559	1941	2644
10 bar	945	1076	1249	1455	1765	2227	3097
11 bar	1062	1204	1402	1632	2012	2571	3691

# Nitrox Membrane Systems

The Nitrox membrane must be supplied with a clean low pressure air supply, this can either come from a high pressure breathing air storage (in combination with a Mixmaster HP) or from a low pressure air compressor with excellent purification before the membrane (in combination with a Mixmaster LP).

The Mixmaster systems differ slightly in their scope of delivery.

## Mixmaster HP

Available in 2 versions, large and small. The Mixmaster HP panels have an HP breathing air inlet with isolation valve and pressure reducer that safely reduces the HP supply down to the desired LP inlet pressure. The Mixmaster HP panels have a large capacity active charcoal filter to ensure no oil enters the membrane.

The HP solution has the advantage of using pure breathing air to feed the membrane, this reduces the risk of membrane contamination. The investment cost are lower than a LP solution, but the running costs are higher. 2 HP compressors offer the ideal solution with redundancy for professional diving centres. If only 1 HP compressor is available then a higher capacity storage will be necessary.

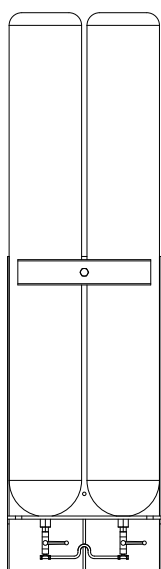

High pressure storage



Pressure reducer, membrane, analyser & reservoir

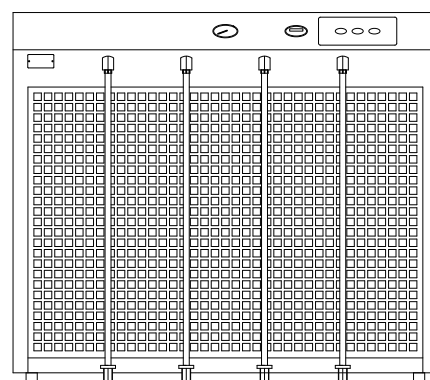

HP compressor (gas tight inlet) and filling hoses

## Technical Data

### Mixmaster HP Technical Data (Capacities and air requirements, see page 51)

Inlet Pressure [bar]	50 > 350 bar (G¼" female)
Membrane inlet pressure LP [bar]:	4 > 11 (11.5 bar safety valve)
Outlet to compressor (air/nitrox):	G1" female
Air inlet (for air filling operations):	G1" female
Dimensions W x H x D [cm]:	65 x 115 x 30
Weight [kg]:	75



# Nitrox Membrane Systems

## Mixmaster LP

Available in 2 versions, large and small. The Mixmaster LP panels have a LP inlet with coarse and fine coalescent filters and a large capacity active charcoal filter for oil removal.

The LP solution is a higher investment but has the advantage of lower running costs compared to the HP version. The LP compressor must be matched to the highest oxygen mixture required.

## Complete Mixmaster LP installations

The Mixmaster LP can also be supplied complete with a matched LP compressor for a turn key installation either complete with a matching HP compressor or just the LP compressor and Mixmaster LP to suit an existing high pressure air compressor that is suitable for nitrox compression.

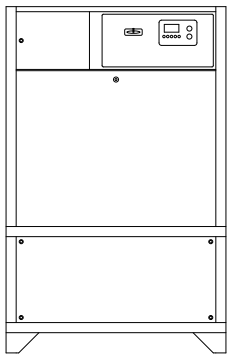

Low pressure compressor  
and air dryer



Pressure reducer, membrane,  
analyser & reservoir

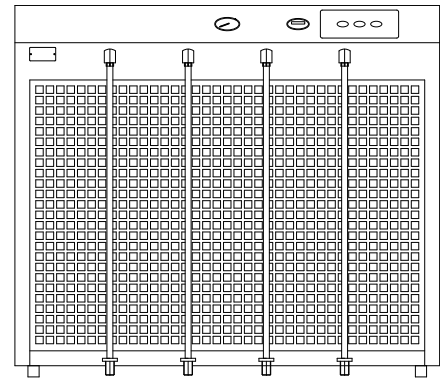

HP compressor (gas tight inlet) and filling  
hoses

## Technical Data

### Mixmaster LP Technical Data (Capacities and air requirements, see page 51)

Inlet Pressure [bar]	4-11 bar (G1" female)
Outlet to compressor (air/nitrox):	G1" female
Air inlet (for air filling operations):	G1" female
Dimensions W x H x D [cm]:	65 x 115 x 30
Weight [kg]:	75

# Gas Blending Panels

## „Safe gas blending“

Using the partial pressure method, Nitrox and/or Trimix can be mixed and filled safely, easily and accurately using our Pro or Classic filling panels. The panels are tested and certified for 100% oxygen and/or helium mixing for all your breathing gas requirements. Practical valve and gauge layout makes operation easy to learn and use.

For pure oxygen compatible air (OCA), we recommend using the Puracon air controller (see page 41) and/or an extra filter mounted on the panel.

Wall mounted panels for safe and easy partial pressure gas blending. All gas inlets are fitted with isolation valves, non return valves and flow restrictors. The oxygen/helium gas pressure can be read on individual pressure gauges without the need to open the valves which makes efficient gas cascading quick and simple. The design of the panels has been approved by the stringent German TÜV authorities as suitable for use in Nitrox, Trimix and Heliox applications.

The Panels have a removable rear cover which makes wall mounting very simple and are powder coated in RAL 6026. All the pipework and the connections are stainless steel providing years of trouble free service and safe gas flow. The valves are industrial quality.

### Nitrox Classic Panel specifications

- >> 2 inlets for oxygen/helium with pressure gauges, 6 mm pipe connections
- >> 1 inlet for OCA, 8 mm pipe connection
- >> 1 outlet for vented gas, 6 mm pipe connection
- >> Main pressure gauge Ø 160 mm class 1.0, 0-250 bar in 2 bar increments
- >> Housing for oxygen analyser/sensor, gas is reduced in pressure and flow
- >> 1 filling hose with cylinder connection of your choice (see page 55)
- >> Up to 3 extra filling hoses can be fitted

### Nitrox Pro Panel specifications

- >> 3 inlets for oxygen/helium with pressure gauges, 6 mm pipe connection
- >> 1 inlet for OCA with pressure gauge, 8 mm pipe connection
- >> 1 outlet for vented gas, 6 mm pipe connection
- >> Main pressure gauge Ø 160 mm class 1.0, 0-250 bar in 2 bar increments
- >> Alpha 1 oxygen analyser (see text opposite) can be used off the panel if required
- >> 1 filling hose with cylinder connection of your choice (see page 55)
- >> Up to 2 extra filling hoses can be fitted

### Options

- >> Inlet purification filter
- >> Alpha 1 analyser (classic)
- >> Additional filling hose(s)
- >> Helium/Oxygen analyser



















## Technical Data

	W x H x D [mm]	Weight [kg]	Max. inlet pressure OCA [bar]	Max. inlet pressure Oxygen/Helium [bar]
Nitrox Classic	710 x 480 x 220	29	200	200
Nitrox Pro	810 x 580 x 220	38	200	200

# Filling Connections

Filling connections for SCBA and diving cylinders in accordance with national/international standards.

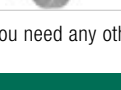
	Gas	Description	Max WP	M16x1.5 mm for HP hose/lever filling valve	G1/4" for Oxygen hose	G1/4" for lever filling valves (old)	M16 x 1.5mm for cross filling valves	8 x 2.5 mm for piping connection
	Air	DIN 477 200 bar	232 bar / 3400 psi	●	●	●	●	●
	Air	DIN 477 200 bar anti whip	232 bar / 3400 psi	●	●			
	Air	DIN 477 300 bar	300 bar / 4500 psi	●		●	●	●
	Air	DIN 477 300 bar anti whip	300 bar / 4500 psi	●				
	Air	DIN 477 300 bar 90° swivel connection	300 bar / 4500 psi	●				
	Air	INT/Yoke for scuba	232 bar / 3400 psi	●	●		●	
	Air	CGA 346	200 bar / 3000 psi	●		●	●	
	Air	CGA 347	300 bar / 4000 psi	●		●	●	
	Air	NF E 29-662	232 bar / 3400 psi	●		●	●	
	Air	NF E 29-662 anti whip	232 bar / 3400 psi	●				
	Air	NF E 29-663	300 bar / 4500 psi	●		●	●	●
	Air	NF E 29-663 anti whip	300 bar / 4500 psi	●				
	Air	Spasciani	200 bar / 3000 psi	●				
	Nitrox	Draeger M24 x 2.0 prEN144	200 bar / 3000 psi		●			
	Nitrox	M26 x 2.0 - 250 bar	250 bar / 3675 psi		●			
	Nitrox	M26 x 2.0 - 350 bar	350 bar / 5000 psi		●			
	O <sub>2</sub>	G3/4" DIN 477	200 bar / 3000 psi		●			

If you need any other connections, please do not hesitate to ask.

# Filter Cartridges

Filter cartridges are available for various applications and various gases. The tables below give an overview of the filter cartridges available.



Order number new (order number old)	Diameter Ø [mm]	Length [mm]	Compressor/ Filter housing	Capacity [m <sup>3</sup> ] at	
				20°C*	35°C*
<b>Breathing air in accordance with EN 12021</b>					
000644	45	200	LW 100 E/E1	108	32
001375 (LW160/190154)	48	165	LW 160 E/E1, 170 E	180	54
001374 (LW225/245154)	48	210	LW 200 E, 225 E	200	60
000002 (4508005)	62	355	LW 210 E/ES, LW 230 E/ES, LW 260 E/ES, LW 280 E/ES, LW 300 E, LW 450 E, 1.7 liter housing	900	270
000003 (8022)	62	575	LW 300 ES, LW 450 ES, LW 570 E/ES, LW 720 E, 2.3 litre housing	1200	360
<b>Breathing air in accordance with EN 12021 and additional CO/CO<sub>2</sub> filtration</b>					
002309	45	200	LW 100 B	86	26
001463 (LW160/190154K)	48	165	LW 170 D, LW 190 B	150	45
001464 (LW225/154K)	48	210	LW 245 B	166	50
001459 (4508005K)	62	355	LW 300 B, LW 450 D	750	225
001461 (4508022K)	62	575	LW 570 D	1000	300

\* Temperature of the filter housing

# Filter Cartridges

Order number new (order number old)	Diameter Ø [mm]	Length [mm]	Compressor/ Filter housing	Capacity
<b>Oil/odour removal &lt; 0,1 mg/m<sup>3</sup> (nitrogen / helium /mixmaster applications)</b>				
002310	45	200	LW 100 EN	Capacity depends on the inlet quality of the gas and the operating conditions, refer to instruction manual
001466 (4508005B)	62	355	LW 300 EN, LW 450 EN, 1.7 litre housing	
001467 (3790)	62	575	LW 450 ESN, LW 570 EN/ ESN, 2.3 litre housing	
001469	90	500	Mixmaster	
<b>Air/inertgas drying only &lt; 15 mg/m<sup>3</sup></b>				
002311	45	200	LW 100	Capacity depends on the inlet quality of the gas and the operating conditions, refer to instruction manual
001464 (4508005A)	62	355	1.7 litre housing	
001462 (8022A)	62	575	2.3 litre housing	
<b>CNG Filter (drying and oil removal)</b>				
002476	45	200	LW 100 EG	Capacity depends on the inlet quality of the gas and the operating conditions, refer to instruction manual
001468 (8070)	62	575	2.3 litre housing	

## Oil and Inlet Filters

### Oil

We have gone to great lengths testing various oil compositions for our compressors. The low carbon build up and the excellent lubrication properties were paramount in the development of our compressor oil.

Oil Type	Order number new (old)	Quantity
Full synthetic for HP breathing air compressors	000001 (4509001)	1 litre
Mineral motor oil for combustion engines	000004 (4509003)	500 ml
Compressor oil for CNG compressors and boosters	002348	20 litre



### Inlet filters









Various inlet filters are available for the different sizes of compressors, the inlet filter cartridge is a low cost component that plays a significant role in protecting the compressors, a clean cartridge also ensures the efficient operation of the compressor.

Inlet Filter Order number new (old)	Compressor
001708	LW 100
000119 (LW160/190/123)	LW 160/170/190/200/225/245
000170 (4507017)	LW 210/230/260/280/300/450/570/720
002662 (1820)	LW 1300







# Filling Valves

	Order number	P max Application	Mount	Repair kit/ special tools/silencer
	<b>Cross design filling valve without pressure gauge</b>			
	Yoke: 002022 DIN 200: 002023 DIN 300: 002024	350 bar Filling valve with separate vent screw	Filling valve without pressure gauge for mounting on a filling hose via a 1/4" female connection (supplied as standard with connection M16 x 1,5 mm 10 L). Available with various filling connections (see page 55).	Repair kit: 002294
	<b>Cross design filling valve with pressure gauge</b>			
	Yoke: 002291 DIN 200: 002292 DIN 300: 002293	350 bar Filling valve with separate vent screw	Filling valve with 0-400 bar pressure gauge for mounting on a filling hose via a 1/4" female connection (supplied as standard with connection M16 x 1,5mm 10L). Available with various filling connections (see page 55)	Repair kit: 002294
	<b>Hand wheel valve without venting</b>			
	001477	350 bar. Standard 2/1 way valve, G1/4" inlet and outlet for opening closing lines such as storage cylinders	Panel mounting with Ø 33 mm hole (mounting nut included)	Lower seat: 000571 Upper valve stem and bearing: 000573
	<b>Hand wheel valve self venting</b>			
	001476	350 bar Standard 2/1 way valve, G1/4" inlet and outlet self venting on the outlet line for filling panels	Panel mounting with Ø 33 mm hole (mounting nut included)	Lower seat: 000572 Upper valve stem and bearing: 000574 Silencer kit: 002896
	<b>Lever filling valve, self venting</b>			
	Black gaiter: 002449 Red gaiter: 002450	350 bar Standard 2/1 way valve, G1/4" inlet and M16 x 1.5 mm outlet self venting on the outlet line for filling panels	Panel mounting inside a 90° profile secured by 4 screws, vents inside the panel	Repair kit small: 002451 Repair kit large: 002452 Tool kit: 002453 Silencer: 000580
	<b>Lever filling valve, self venting (old version)</b>			
	Black gaiter: 001382 Red gaiter: 001383	350 bar Standard 2/1 way valve, G1/4" inlet and outlet self venting on the outlet line for filling panels	Panel mounting inside a 90° profile secured by 4 screws, vents inside the panel. (limited availability)	Repair kit: 000576 Special tool: 000575 Silencer: 000580
	<b>Lever filling valve, self venting</b>			
	Black gaiter: 000707 Red gaiter: 000708	350 bar. Standard 2/1 way valve, G1/4" inlet and M16 x 1,5mm male outlet, self venting on the outlet line for filling panels with hoses	Panel mounting with Ø 23 mm hole (mounting nut included) silencer integrated in the vent	Repair kit: 000576 Special tool: 000575
	<b>Lever filling valve, self venting</b>			
	001827	350 bar Standard 2/1 way valve, G1/4" inlet and M16 x 1.5 mm outlet self venting on the outlet line for filling	Vertical panel mounting with U Clamp	U Clamp: 001826 Repair kit small: 001834 Repair kit large: 001836

# Safety Valves

## Safety valves



Safety valves are available for various pressures, either securing the final pressure on HP compressors and installations or preventing damage to inter stage or low/medium pressure components.

	Pressure setting	Mount	certification
	100 - 350 bar	Special mount	TÜV / CE
	100 - 350 bar	G3/8"	Non type tested
	8 - 110 bar	G3/8"	CE/non type tested

# Pressure Switches

## Pressure switches and sensors

A wide range of analogue pressure switches and electronic pressure sensors is available suitable for pressures between 0 and 600 bar.

	Pressure setting available	Mount	Operation
	0 - 10 bar 0 - 350 bar 0 - 600 bar	G1/4" female	Switch opens at set pressure, resets after hysteresis
	0 - 1.6 bar 0 - 4 bar 0 - 100 bar 0 - 600 bar	G1/4" male	Electronic sensor 14-30V DC input, 0-10 V DC output

# Air Inlet Silencer

## Air Inlet Silencer

If the compressor inlet hose is led outside for clean fresh air to enter the compressor, the noise generated by the inlet valve that resonates within the hose can be reduced to an almost inaudible level by mounting the inlet silencer at the end of the hose.

The silencer comes with a special mount for wall mounting.

40 x 26 x 60 cm, 24 kg

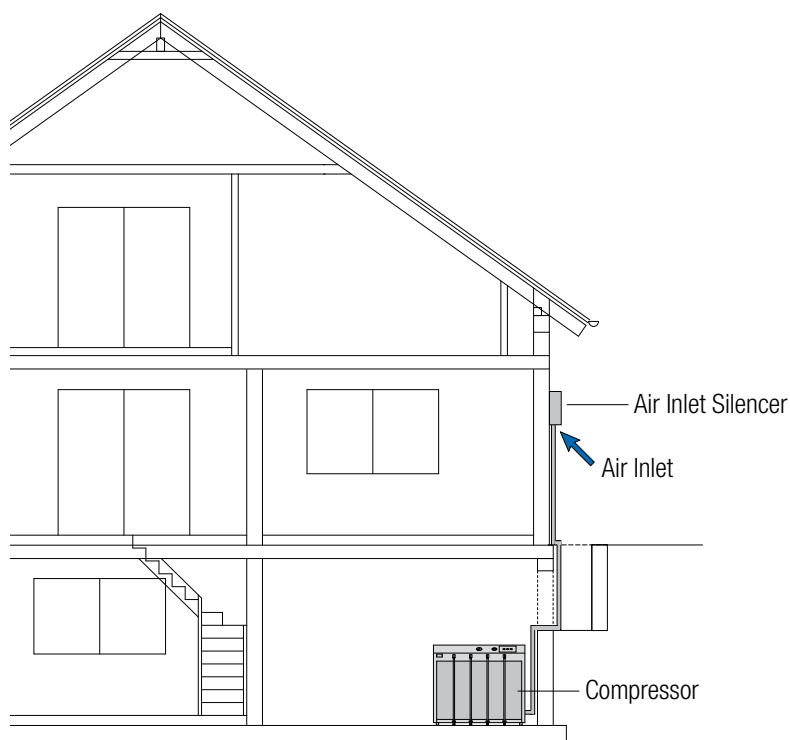

# Condensation Collecting Tank

## Condensation Collecting Tank

The L&W condensation collecting tank has been specially designed to collect the condensation from the high pressure compressor (up to 4 stages) with gas tight lines directly from the drain valves. The large volume allows the air that accompanies the condensation to expand within the 60 litre tank and then escape through an active charcoal filter and silencer, thus reducing the noise to a minimum and preventing odours escaping from the tank.

The tank is available with an optional float and switch that can be used to shut down the compressor when the condensation drain tank needs to be emptied.

Ø 40 x 80 cm, 20 kg



# Pressure Reducing Stations

## Pressure reducing stations

Ideal for safely reducing storage pressure down to the required filling pressure. The pressure reducing stations are available with various inlet and outlet pressures and high flows for large capacity applications.



Pressure reducing station with non type tested safety valve



Pressure reducing station with TÜV/ CE safety valve

# Pressure Reducers

## Pressure reducers

Various pressure reducers are available for different applications with adjustable outlet pressures and various flow rates to suit most applications.

	Inlet	Outlet	Gas
	100-420 bar 2 x 1/4" NPT female	27 - 300 bar 2 x 1/4" NPT female	Air / inert gas
	100-420 bar 1 x 1/4" NPT female	27 - 300 bar 1 x 1/4" NPT female	Air / inert gas
	100 - 300 bar G5/8" DIN 477 male	0-50 bar G1/4" female	Air / inert gas

# Adapters

	Order number	From	To	Material
	000683	DIN 200 bar G5/8" female	G1/4" female	Stainless steel
	001496	DIN 200 bar G5/8" female	G1/4" female with M22 x 1.5mm male	Stainless steel
	000684	DIN 300 bar G5/8" female	G1/4" female	Stainless steel
	001497	DIN 300 bar G5/8" female	G1/4" female with M22 x 1.5mm male	Stainless steel
	000685	DIN 200 bar G5/8" male	G1/4" female	Brass
	000686	DIN 300 bar G5/8" male	G1/4" female	Brass
	000214	DIN 200 bar G5/8" female	INT/Yoke A clamp connection	Chromed brass
	001478	DIN 200 bar G5/8" female (for anti whip connections)	INT/Yoke A clamp connection	Chromed brass
	001479	DIN 200 bar G5/8" female (for anti whip connections, old version with Pin)	INT/Yoke A clamp connection	Chromed brass
	002903	2 x DIN 300 bar G5/8" female	G1/4" female	Stainless steel
	003096	W28.8 x 1/142 tapered thread DIN 477	G1/4" female	Brass



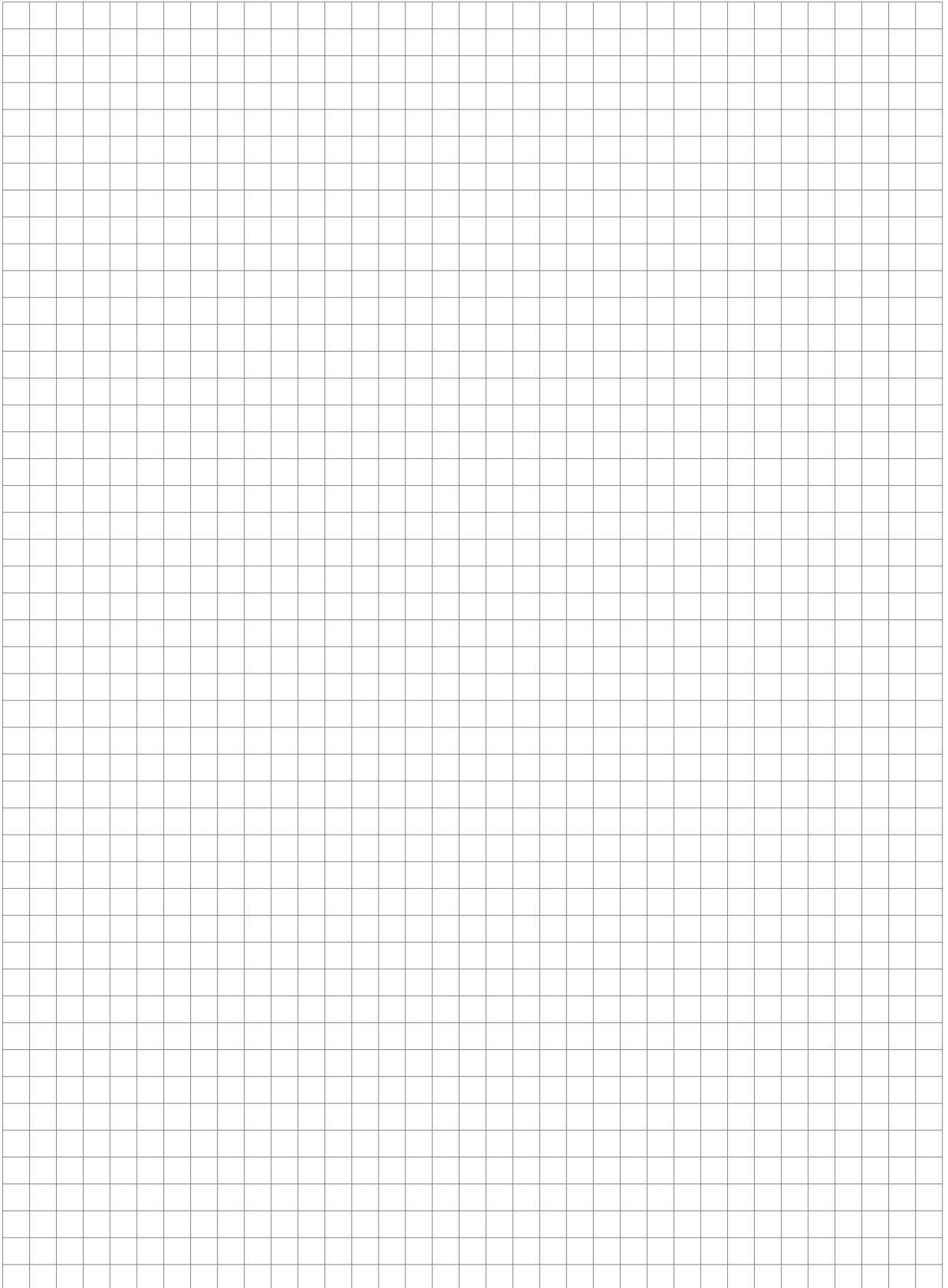



## High Pressure Solutions from L&W!

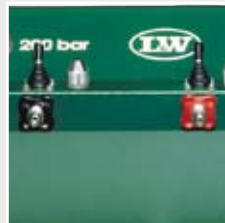

### **Lenhardt & Wagner GmbH**

Bensheimer Strasse 100

64653 Lorsch / Germany

Phone: +49 - 62 51 - 10 74 -0

Fax: +49 - 62 51 - 10 74 -14

eMail: [info@lw-compressors.com](mailto:info@lw-compressors.com)

Internet: [www.lw-compressors.com](http://www.lw-compressors.com)